



mainroads
WESTERN AUSTRALIA

Traffic Management for Works on Roads

CODE OF PRACTICE



TRAFFIC MANAGEMENT FOR WORKS ON ROADS ***CODE OF PRACTICE***

All printed copies are uncontrolled

Main Roads Western Australia
Planning and Technical Services Directorate
Road Safety Branch

December 2021

This document was originally endorsed by the Traffic Management for Works on Roads Advisory Group on 3 March 2004. Revisions are endorsed by the Advisory Group and approved by Main Roads Executive Director Planning and Technical Services. The Advisory Group consists of members from Main Roads Western Australia (Main Roads), Australian Institute of Traffic Planning and Management (WA division) (AITPM), Civil Contractors Federation (CCF), Institute of Public Works Engineering Australia (WA division) (IPWEA), Traffic Management Association of WA (TMAWA), WA Local Government Association (WALGA), WA Police (WAPOL), Traffic Management Training Providers, Utility Providers and Engineers Australia (WA division).

A specialist Technical Committee comprising members from Main Roads, IPWEA (WA division) and WALGA has provided technical advice in regard to various sections of this document.

Amendments to this document may be made from time to time reflecting the changes in technology, standards or legislation as well as the feedback from the industry, subject to endorsement by the Advisory Group. Users of this document are warned to make sure that they are using the current document which is available on Main Roads website at www.mainroads.wa.gov.au; go to 'Technical & Commercial' > 'Working on Roads'

AMENDMENT / REVISION STATUS RECORD

Date	Section	Amendment / Revision Description
December 2021	Section 1.3.1	Adoption of AGTTM version 1.1.
	Section 2	Clarification added for approval times
	Section 2.1.1	Reference to Smart Freeway TGS
	Section 2.1.2	Clarification - Traffic Management Registration Scheme required for lane closure or speed limit implementation
	Section 4.2.3	Reference to '80km/h' removed from third dot point in item ii
	Section 4.2.5	New section - Traffic Management Implementation and Removal
	Section 4.3	Clarification – pre-treatment risk rating for works near live traffic
	Section 4.4.1	Clarification - Dot point 4 'children's crossing' with no Traffic Warden changed to 'pedestrian crossing'
	Section 6.1	Signs to be manufactured in accordance with Main Roads Specifications
	Section 6.1.9	New section – Sign Spacing
	Section 6.2.2	Reference to AS1742.3 added
	Section 6.2.3	MMS to be manufactured in accordance with Main Roads Specifications
	Section 6.5	Note added to table 5 for approach speeds of 70 km/h
	Section 6.8.1	Modification of centreline cones
	Section 6.8.2	Clarification - stopping distance may exceed table 10. Addition of Queued Traffic signs
	Section 6.8.3	PTCD requirements updated
	Section 6.8.5	New section - Stop-slow bats
	Section 6.9	TMA guideline name change, document updated
	Section 6.10	Warning lamp requirements added
	Section 6.11	Removal of traffic volume departures now included in AGTTM
Section 6.12	Mobile work departures added for distance of shadow	

vehicle and advance warning vehicles.

Section 6.13	New section - Shadow Vehicles
Section 7.2	Reference to AS 5156 added
Section 7.3	Speed feedback sign requirements added
Section 7.4	New section – Traffic Monitoring and Surveillance
Appendix 1	Addition of 'Must' definition
Appendix 5	MMS-ADV-22 not to be used in conjunction with a regulatory sign
	MMS-POS-8 should be used with ON SIDE ROAD
	MMS-REG-2 may be used on mobile convoys
	New signs: Advance Warning Series: MMS-ADV-90 to MMS-ADV-101
	Event Series: MMS-EVE-10
	Regulatory Series: MMS-REG-14

February 2021	Whole document	Adoption of the Austroads Guide to Temporary Traffic Management
	Whole document	References to AS1742.3-2009 changed to AS1742.3-2019.
	Section 1	Scope and Introduction combined.
		Addition of Austroads Safety at Road Worksites project.
	Sections 2, 3 and 4	Sections moved forward (due to Scope and Introduction combined)
	Section 2.1.2	Traffic management company registration scheme on site personnel requirement added.
	Section 4.4	Children's Crossings and School Zones and Railway Crossings (Including Crossings without Flashing Signals) sub-sections relocated to 4.4.1 Consultation
	Section 5	Sections 5.5 Traffic Management Records and 5.7 Reviewing, Auditing and Approving Traffic Management combined and renamed Review, Inspection, Road Safety Audit and Operation
	Section 6	Due to updates to AS1742.3 and AGTTM the following sub sections removed: Dimension D Signs for Managing Pedestrians Guidelines for use of MMS Offset Speed Zones on Undivided roads

		<p>Mobile Temporary Speed Zones Excavations and Other hazards Overhead Works on or near Roads Pedestrian Protection in Contra-Flow Situations Works on Residential Access Roads Fatality or Serious Injury at Worksite</p>
	Section 6.1.7	New section – Repeater Speed Restriction Signs
	Section 6.3	Additional guidance for securing signs and devices
	Section 6.8	New requirements for where traffic control is not permitted
		Requirements for use of PTCs
	Section 6.10	Recommendation for size of Illuminated Flashing Arrow Sign added
	Section 8	Sub-sections rearranged
		New accreditation – BWTM non-practitioner Removal of Provisional Accreditation
		Provisional accreditation removed
	Appendix 1	Removal of definitions within AGTTM Part 1
	Appendix 4	Notification of Roadworks Form updated – additional HVS requirements
	Appendix 5	New signs: MMS-ADV-85, MMS-ADV-85, MMS-ADV-86, MMS-ADV-87, MMS-ADV-88, MMS-ADV-89, MMS-REG-8, MMS-REG-9, MMS-REG-10, MMS-REG-11, MMS-REG-12, MMS-REG-13
July 2020	Appendix 4	Main Roads WA regional contacts updated Notification of Roadworks Form Distribution List updated
	Appendix 5	MMS-ADV-83 and MMS-ADV-84 signs added
May 2020	Section 3.3; 4.5; 5.2.3; and 6.8.1	All traffic control procedures at permanent traffic signals relocated to the Temporary Traffic Management: Traffic Signal Approval Policy
	Section 9.1	Adoption of the AGTTM in Western Australia postponed to February 2021.
January 2020	Section 3.1.1	Traffic Management at Roadworks on State Roads Policy and Application Guidelines updated
	Section 3.1.3	New Section – Works on MRWA Roads in the

Metropolitan Area

Section 5.2.2	New section - Generic TMPs; Generic TMP Checklist updated; TGS selection process added
Section 5.2.3	RTM site visit exception added
Section 5.4	Section renamed Consultation, Communication and Notifications of Roadworks; requirements added for Transperth approval; amendments to Notification of Approved Roadworks amended
Section 5.5	Requirement for Daily Diary to be based on template; clarification to record implemented TGS.
Section 6.3.4	Additional requirement added for using core flute MMS
Section 6.5.4	Requirements updated for Delineation of Temporary Road Safety Barriers
Section 6.8.2	Railway Crossing requirements updated
Section 6.13	New section - Traffic Control; Avoiding End of Queue Collisions requirements added
Section 6.15	Securing signs section relocated
Section 6.16	Covering Speed Limit Road Marking relocated and renamed to Covering Regulatory Road Marking
Section 7.6	New section – Speed Feedback Signs
Section 8.1	Clarification – Traffic Controller tasks include operating portable traffic control devices
Section 8.5	AWTM accreditation – removed RIIWHS201D and RIIGOV401D
Section 8.7	RTM pre-requisites amended
Section 9	New section – Austroads Safety at Road Worksites

Sep
2018

Section 3.1	Additional text added regarding planning works.
Section 5.6	Table 4.9 of AS1742.3 added to traffic flow variations.
Section 6.8.1	Reference to Traffic Operations Centre (TOC) replaced with Road Network Operations Centre (RNOC). Spelling error amended.
Appendix 4	TOC replaced with RNOC and email address updated.
Appendix 5	Signs MMS-ADV-4, MMS-ADV-5, MMS-DIV-6, or MMS-DIV-7 not to be used in conjunction with a regulatory sign. Text added for use of MMS-REG-4.

MMS example configurations amended.

March 2018	Whole Document	Terminology Change - Traffic Guidance Scheme to replace Traffic Control Diagram
	Section 4.5	New section – Authorising Traffic Management Plans
	Section 5.2.1	Requirement to use the Main Roads TMP template
	Section 5.2.2	Complex traffic arrangements updated; complex TMPs prepared by RTMs to be endorsed by another RTM
	Section 5.2.3	Requirements for Temporary Road Safety Barrier Details updated
	Section 5.3	Risk Management requirements updated
	Section 5.6	Amendments to Variation to the code and standards requirements
	Section 5.7	More details added for reviewing, auditing, and approving traffic management
	Section 6.1.8	New sign – Narrow Temporary Hazard Marker
	Section 6.1.9	New sign – STOP HERE WHEN DIRECTED
	Section 6.3.2	MMS amendments – allowing Lane Status and Road Condition signs to have more than 2 Panels the same colour
	Section 6.5.4	Amendments to delineation of temporary barriers
	Section 6.8.1	Amendments to requirements at traffic signals
	Section 6.8.2	Amendments to requirements at railway crossings
	Section 6.11	Adoption of the Guidelines for the use of TMAs in WA
	Section 7.5	New section – Securing signs
	Section 7.6	New section – Innovative traffic control devices
	Section 8.2	BWTM accreditation – allowing BWTM to directly supervise implementation of signs on low-speed local roads
	Section 8.5	AWTM accreditation - Addition of one year experience added to prerequisites

Foreword

Western Australia has over 170 000 kilometres of roads, which periodically require re-construction, maintenance or work on services within their road reserve. With current economic recovery efforts, in response to the COVID-19 pandemic being focused on provision of public infrastructure, more than \$8 billion of funding has been allocated to transport projects. This will significantly increase the amount of works being conducted on Western Australian roads. If not managed well, these tasks have the potential to create hazardous situations for both road workers and users that may produce serious or even fatal consequences.

Main Roads Western Australia has adopted the Safe System approach to managing the road network and the Traffic Management for Works on Roads Code of Practice utilises these principles. This Code provides mechanisms to protect all road users (including road workers), acknowledging that people are fallible and have limited ability to tolerate impact forces.

I have authority under Regulation 297 of the Road Traffic Code 2000, to erect, establish or display, alter or take down any road sign or traffic control signal. With this comes a duty of care to facilitate the safe and appropriate use of road signs and devices. These requirements have been developed in conjunction with key stakeholders in recognition of this obligation.

The requirements promote safe and consistent traffic management practice at work sites on roads in accordance with state legislation and national standards. They require general compliance with the Austroads Guide to Temporary Traffic Management (AGTTM) and Australian Standard 1742.3 - 2019, with details of additional requirements necessary to meet Western Australian requirements and advise of departures to the requirements of the AGTTM and Australian Standard that I am prepared to allow on Western Australian roads. The requirements also outline the competency requirements for personnel responsible for managing traffic on work sites and the need to hold a qualification relevant to the specific task in traffic management.

This document, initially released in March 2004, has been prepared following extensive consultation with local government, industry and other stakeholders through Advisory Group meetings, Technical Committee meetings, a technical workshop and other forums.

I encourage all persons involved in managing traffic at work sites on roads to fully familiarise themselves with these requirements, to apply them with due consideration to the situations that present to them and to carefully comply with the mandatory requirements. This will result in safer work sites for yourselves, your fellow workers and all road users.

Peter Woronzow
A/COMMISSIONER OF MAIN ROADS

Contents

1. INTRODUCTION AND SCOPE	12
1.1 INTRODUCTION	12
1.2 SCOPE	12
1.3 AUSTRROADS SAFETY AT ROAD WORKSITES	13
1.3.1 Austroads Guide to Temporary Traffic Management	13
1.3.2 Road Categories and Training	15
2. APPROVAL TO WORK WITHIN ROAD RESERVES	16
2.1 ROADS FOR WHICH MAIN ROADS IS RESPONSIBLE	16
2.1.1 Main Roads Policy for Works on High Volume Roads	17
2.1.2 Traffic Management Company Registration Scheme	17
2.1.3 Works on Main Roads Roads in the Metropolitan Area	18
2.2 ROADS FOR WHICH LOCAL GOVERNMENT OR OTHERS ARE RESPONSIBLE	18
2.3 WORKS AFFECTING TRAFFIC SIGNAL OPERATION	18
3. AUTHORITY TO ERECT TRAFFIC CONTROL DEVICES	19
3.1 MAIN ROADS	19
3.2 MAIN ROADS AGENTS	19
3.3 AUTHORISED BODIES AND THEIR AGENTS	19
3.4 OTHERS NOT PARTY TO AN INSTRUMENT OF AUTHORISATION	19
3.5 AUTHORISING TRAFFIC MANAGEMENT PLANS	20
4. PLANNING THE WORKS	21
4.1 DUTY OF CARE	21
4.2 TRAFFIC MANAGEMENT PLANS	21
4.2.1 General	21
4.2.2 Generic TMPs	22
4.2.3 Traffic Management Plans Involving 'Complex Traffic Arrangements'	23
4.2.4 Temporary Road Safety Barrier Detail in TMPs	25
4.3 RISK MANAGEMENT	25
4.4 CONSULTATION, COMMUNICATION AND NOTIFICATION OF ROADWORKS	26
4.4.1 Consultation	27
4.4.2 Notification of Approved Roadworks	29
4.5 VARIATION TO THE CODE, AGTTM AND STANDARDS	30
5. REVIEW, INSPECTION, ROAD SAFETY AUDIT AND OPERATION	31
5.1 REVIEW, INSPECTION AND ROAD SAFETY AUDIT	31
5.1.1 Audits	31
5.1.2 Suitability Reviews and Compliance Safety Inspections	31
5.1.3 Suitability Check	32
5.1.4 Review and Audit Checklists	32
5.2 TRAFFIC MANAGEMENT OPERATION AND RECORDS	32
6. DEPARTURES FROM DESIGN REQUIRMENTS IN AS1742.3 AND AGTTM	33
6.1 TEMPORARY SIGNAGE	33
6.1.1 General	33

6.1.2	REDUCE SPEED Signs	33
6.1.3	NEW WORK NO LINES MARKED Signing	34
6.1.4	ROAD INSPECTION Sign	34
6.1.5	CYCLIST DISMOUNT Sign	34
6.1.6	Pedestrian Warning Signs for Motorists	35
6.1.7	Repeater Speed Restriction Signs	35
6.1.8	ROAD CLOSED and FOOTPATH CLOSED Signs	35
6.1.9	Sign Spacing	35
6.2	GUIDELINES FOR MULTI-MESSAGE SIGNS	36
6.2.1	Introduction	36
6.2.2	Frames for Multi-Message Signs	36
6.2.3	Substrates for Multi-Message Signs	36
6.3	SECURING SIGNS AND DEVICES	37
6.3.1	Securing Signs	37
6.3.2	Securing Cones and Bollards	38
6.4	COVERING EXISTING SIGNAGE AND ROAD MARKING	38
6.4.1	Existing Signs	38
6.4.2	Covering Regulatory Road Marking	38
6.5	SPEED LIMIT ZONES	39
6.5.1	Approval of Temporary Speed Limit Signs	39
6.5.2	Setting out Temporary Speed Zones (Buffer Zones)	39
6.6	TEMPORARY ROAD SAFETY BARRIER SYSTEMS	42
6.6.1	Delineation of Temporary Road Safety Barriers	42
6.6.2	Barrier Edge Clearances	43
6.7	MINIMUM LANE WIDTHS	44
6.8	TRAFFIC CONTROL	44
6.8.1	Advanced Warning Signs	44
6.8.2	Avoiding End of Queue Collisions	46
6.8.3	Portable Traffic Control Devices	49
6.8.4	Traffic Controllers	49
6.8.5	Stop-Slow Bats	49
6.9	TRUCK MOUNTED ATTENUATORS	50
6.10	ILLUMINATED FLASHING ARROW SIGN	50
6.11	TRAFFIC VOLUME	50
6.12	MOBILE WORKS	51
6.13	SHADOW VEHICLE	52
7.	BEST PRACTICE	53
7.1	INNOVATIVE TRAFFIC CONTROL DEVICES	53
7.2	ELECTRONIC SPEED LIMIT SIGNS	53
7.3	SPEED FEEDBACK SIGNS	54
7.4	TRAFFIC MONITORING AND SURVEILLANCE	54
8.	ACCREDITATION REQUIREMENTS	55
8.1	GENERAL	55
8.2	TRAFFIC CONTROLLER ACCREDITATION	56
8.3	BASIC WORKSITE TRAFFIC MANAGEMENT ACCREDITATION	57
8.3.1	Basic Worksite Traffic Management - Non - Practitioner	57
8.4	WORKSITE TRAFFIC MANAGEMENT ACCREDITATION	58
8.5	ADVANCED WORKSITE TRAFFIC MANAGEMENT ACCREDITATION	58

8.6	ROADWORKS TRAFFIC MANAGERS ACCREDITATION	59
8.7	OPERATE TRUCK MOUNTED ATTENUATOR	60
8.8	PROOF OF CERTIFICATION	60
8.9	ISSUE OF CERTIFICATION AND RE-ACCREDITATION	60
9.	FURTHER INFORMATION	61
10.	REFERENCES	61
Appendix 1:	Definitions	i
Appendix 2:	Traffic Risk Classification	iv
Appendix 3:	Typical Instrument of Authorisation for Local Government	vii
Appendix 4:	Sample 'Notification of Roadworks' Form	x
Appendix 5:	Multi-Message Sign Inventory and Application Schedule	xiii

1. INTRODUCTION AND SCOPE

1.1 INTRODUCTION

This Code of Practice (herein after referred to as the 'Code') describes the Main Roads Western Australia's (Main Roads) requirements for managing traffic at work sites on roads. It requires traffic management for works on roads to be based on the Austroads Guide to Temporary Traffic Management (AGTTM) and AS 1742.3–2019, unless otherwise specified by a requirement in this Code. In the event that there is a conflict between this Code and AGTTM or AS 1742.3 – 2019, the Code shall take precedence.

The purpose of this Code is to specify any variations or additional requirements to AGTTM and AS 1742.3 – 2019 which are required at works on roads in Western Australia.

The prescribed practices are the minimum requirements, on which the Traffic Management Plans (TMPs) for all Western Australian roads shall be based. Main Roads recognises that situations sometimes arise where application of these requirements is not appropriate and that variation to these requirements will be necessary. When it becomes apparent that deviation is necessary from the requirements of this Code, persons arranging the works should carefully consider all possible options, using common sense and judgment based on 'risk management' carried out in accordance with sections 4.3 and 4.5. Further, they shall ensure that their actions are consistent with related legislation.

See AGTTM Part 1 for more details on Temporary Traffic Management (TTM) purpose, philosophy and principles.

Practitioners should be aware of the document titled [Traffic Management for Events Code of Practice](#) that has been placed on Main Roads' website - see 'Technical and Commercial' > 'Working on roads'. This document has been designed to complement the Traffic Management for Works on Roads Code of Practice in respect to the various traffic management issues that are common to works on roads and to events, particularly in respect to the design and implementation of Traffic Management Plans.

1.2 SCOPE

This Code applies to all work conducted within all road reserves throughout Western Australia and the planning of any proposed works.

Where it appears in the Code the term 'work' refers to:

- construction and maintenance work in work sites wholly or partly within the road reserve boundaries and shall apply in any situation where traffic control devices are used to warn, instruct and guide road users in the safe negotiation of work sites on roads including unsealed roads together with footpaths, shared paths, and bicycle paths adjacent to the roadway; or
- any other works which cause interference or obstruction to the normal use of a road by any road user.

This Code is applicable to traffic management for road and bridge construction and maintenance sites, as well as works associated with other public utilities and services.

1.3 AUSTROADS SAFETY AT ROAD WORKSITES

1.3.1 Austroads Guide to Temporary Traffic Management

The 2019 update of AS1742.3 by Standards Australia has resulted in the removal of content from the existing standard (2009) that has been determined to be guidance material, which is not appropriate to locate within an Australian Standard. This guidance material has now been substantially transferred into the Austroads Guide to Temporary Traffic Management (AGTTM) with an expansion to the guidance material based on information from Austroads member organisations.

The Guide to Temporary Traffic Management (AGTTM) is a set of comprehensive Austroads publications developed to provide a best practice reference for the development of safe, cost effective and efficient Temporary Traffic Management (TTM) solutions for Australia and New Zealand. Comprised of 10 parts, AGTTM is now freely available on the Austroads website (www.austroads.com.au go to 'Transport Network Operations' > 'Temporary Traffic Management').

AGTTM version 1.1 has now been adopted in Western Australia. Note: no changes were made to AGTTM Part 8.

The table below outlines the WA adoption of AGTTM, sections refer to sections of this Code.

	Part	Name	WA Adoption and Code of Practice Reference
	1	Introduction and General	Adopted
Planning	2	Traffic Management Planning	Adopted, refer to section 4* for additional WA Traffic Management Planning requirements
Design	3	Static Work Sites	Adopted, refer to section 6* for WA departures and additional requirements
	4	Mobile Works	Adopted, refer to section 6.12 for WA departures
	5	Short Term Low Impact Works	Adopted
Field	6	Field Staff – Implementation and Operation	Adopted, refer to section 5.2* for additional requirements
	7	Traffic Controllers Instructions	Adopted, refer to section 6.8* for departures and additional traffic controller requirements
Support	8	Processes and Procedures	<ul style="list-style-type: none"> • Road Categories for TTM – see section 1.3.2* • Process for TGS Selection – incorporated in section 4.2.2* • TTM approvals – refer to section 2* • Powers and Responsibilities – adopted with additional WA specific information in section 2* and 3* • TTM Training Framework – see section 1.3.2* • Standard Forms – WA forms on the Main Roads website have been retained
	9	Sample Layouts	Adopted, refer to section 6* for WA departures for TGS design
	10	Supporting Guidance (Risk Management, Surveillance, Events)	<ul style="list-style-type: none"> • Risk Management for TTM – see section 4.3* • Review, Inspection and Road Safety Audit – see section 5* • Events on Roads – refer to the Traffic Management for Events Code of Practice • Emergency Works - adopted

Table 1 – AGTTM Adoption

*All references refer to sections of this Code.

1.3.2 Road Categories and Training

Austrroads TTM Road Categories

A road categorisation system has been adopted in the AGTTM based on the New Zealand road levels. While all works on roads are considered high risk, the categorisation into three categories allows design practices and training to be tailored to the different risk levels at each category.

See AGTTM Part 8 for more details.

The WA road network is yet to be categorised, this will be done in consultation with Road Authorities prior to the tiered approach to training and company prequalification being rolled out. Unless this Code states otherwise any recommendations or requirements within AGTTM based on road categories should be considered as a guide.

Austrroads National Training Framework for TTM

The national training framework is not currently adopted in WA, refer to section 8 for WA training and accreditation requirements.

Details of the National Austrroads Training Framework are within AGTTM Part 8

Austrroads will be developing the entire training package, this has been delayed and is scheduled to be completed in the second quarter of 2022. Following project completion there will be an 18-month transition period before the framework is adopted in WA. Those within industry will then be trained under the tiered approach over the following 3 years.

2. APPROVAL TO WORK WITHIN ROAD RESERVES

Prior to commencing works, approval shall be obtained from the agency responsible for the care, control and management of the relevant roads. Care should also be taken to ensure that all other required authorisations are obtained prior to the commencement of works. These might include agreement to any variations to the application of this Code of Practice and/or AGTTM / Australian Standards, as well as any development, heritage, environmental, and cultural clearances. Lengthy delays may be experienced if all necessary approvals are not obtained, increasing the risk of undesired traffic incidents.

In addition to obtaining approval to work within the road reserve from the relevant Road Authority, other agencies such as emergency services, Police, public transport etc. in the area may need to be notified in advance of the impending works as detailed in section 4.4.

All approvals to conduct works on roads issued by Main Roads, local governments or other Authorities responsible for roads, shall be suitably noted on the Traffic Management Plan. A mandatory condition requiring traffic management to be carried out in accordance with the requirements of this Code, subject to any agreed variations, shall be included with the approval.

Approved implementation times for Traffic Management Plans and/or Traffic Guidance Schemes are generally based on traffic capacity. Therefore, unless otherwise stated, no devices are permitted to close traffic lanes prior to the approved start time and all lanes must be reopened to traffic at or prior to the approved finish time.

2.1 ROADS FOR WHICH MAIN ROADS IS RESPONSIBLE

The Commissioner of Main Roads (CMR) is responsible for the care, control and management of the land over which any declared 'highway' or 'main road' exists. Any party intending to conduct work on any 'highway' or 'main road' reserve shall obtain prior approval from Main Roads.

Main Roads has developed comprehensive guidelines and an application kit for those intending to undertake work within any 'highway' or 'main road' reserve in regard to 'complex works', 'low complexity works' or 'utility service works'. These guidelines including contact details and the application kit are available on the Main Roads website at www.mainroads.wa.gov.au; go to 'Technical and Commercial' > 'Working on Roads' > 'Third Party Works'.

To facilitate prompt approval of applications to work on roads, persons arranging works should contact the relevant Main Roads Regional Office at an early stage to obtain traffic information, the level of service required on the road during the works and details of any other requirements that need to be considered whilst preparing their Traffic Management Plans (TMPs).

Typically, the proposed works and staging should be determined and approved in principle prior to any TMP being produced. Once in principle approval for the works has been obtained, the TMP designer should gain a comprehensive understanding of the project staging and then an appropriate TMP can be produced. The TMP should be reviewed by the construction / project manager for suitability prior to being submitted to Main Roads to review and authorise. Depending on the complexity of the project, the time allowed for Main Roads to review should be approximately 15 working days. For works at traffic signals refer to section 2.3.

Further information on preparing TMPs is provided in section 4.2.

Main Roads requires submission of a TMP with all applications to work within its road reserves. TMPs for the metropolitan area shall be sent to enquiries@mainroads.wa.gov.au. If the works are occurring outside the metropolitan area TMPs shall be submitted to the relevant regional office using the generic email address in Appendix 4.

Main Roads will, as it considers necessary, conduct audits of TMPs and refer those that do not comply with the requirements of this Code, back to the proponent for submission of an acceptable TMP prior to allowing commencement of works.

Any organisations with statutory authority to enter Main Roads road reserves in emergency situations shall advise the Main Roads Customer Information Centre (Ph. 138 138) of their work either prior to, or as soon as possible after commencing any emergency service.

2.1.1 Main Roads Policy for Works on High Volume Roads

Main Roads requires roadworks on its high volume roads to be managed with due consideration to traffic efficiency. A policy has been established which puts in place elevated standards of traffic management on high volume roads. This Policy and Application Guideline is titled [Traffic Management at Roadworks on State Roads](#). The policy can be found on Main Roads' website www.mainroads.wa.gov.au go to 'Technical and Commercial' > 'Technical Library' > 'Road and Traffic Engineering' > 'Traffic Management' > 'Temporary Traffic Management'

The policy sets controls on speed limits, lane closures, merges, emergency lanes, Smart Freeways, worksite access and work times for planned maintenance works. Further advice, tools and recommendations are provided, such as real time traffic monitoring and a congestion calculator for traffic management planners.

Note, Traffic Guidance Schemes and a TMP template has been developed by Main Roads Road Planned Interventions (RPI) section for works on Smart Freeways. Contact RPI, via email enquiries@mainroads.wa.gov.au or phone 138 138, for any planned works on any sections of the Smart Freeways.

2.1.2 Traffic Management Company Registration Scheme

The Traffic Management Company Registration Scheme applies to all parties, including local governments and Authorised Bodies that implement lane / road closure or speed restriction on State roads. This applies to all State roads across Western Australia. The guidelines including contact details and the application kit are available on Main Roads website at www.mainroads.wa.gov.au ; go to 'Technical and Commercial' > 'Working on roads' > 'Traffic Management Company Registration Scheme'.

Traffic management sites involving 'complex traffic arrangements' on Main Roads controlled roads, shall have at least one person with either Worksite Traffic Management or Advanced Worksite Traffic Management accreditation on-site at all times when road workers are present.

Refer to the Austroads website for details on the Austroads Traffic Management Prequalification Scheme. Go to www.austroads.com.au > 'Network and Freight' > 'Temporary Traffic Management.' When available, details on the Main Roads adoption and transition will be provided on the Traffic Management Registration page of the Main Roads website.

2.1.3 Works on Main Roads Roads in the Metropolitan Area

Implementing approved traffic management on the Main Roads road network can often cause congestion that may be flagged by the Road Network Operations Centre (RNOC) as an incident.

To avoid any confusion with RNOC, and potential delays to works, it is recommended that immediately prior to implementing approved traffic management on Main Roads controlled roads in the metropolitan area, the traffic management personnel onsite contact the Main Roads Road Network Operations Centre (RNOC) on 138 111.

2.2 ROADS FOR WHICH LOCAL GOVERNMENT OR OTHERS ARE RESPONSIBLE

Any party including utility service providers who are Authorised Bodies intending to conduct works on a road reserve that is not a declared 'highway' or 'main road', shall prior to commencing the works, contact the relevant local government or the other Authority that is responsible for the care, control and management of the road to confirm their requirements.

Location	Contact
Main Roads reserve in Perth Metropolitan Region	enquiries@mainroads.wa.gov.au
Main Roads reserve outside Perth Metropolitan Region	The relevant Main Roads Regional Office - see Appendix 4
Local government road reserve	The relevant local government
Other road reserves	The Authority responsible for the road

Table 2 - Where to obtain approval to work in road reserves

2.3 WORKS AFFECTING TRAFFIC SIGNAL OPERATION

Where the proposed traffic management involves modification to existing signal phasing, number of traffic lanes and / or timing on local OR state roads; the proposed changes to these devices are to be submitted to Main Roads accordance with the [Temporary Traffic Management: Traffic Signal Approval Policy](#) available on the Main Roads website at www.mainroads.wa.gov.au; go to 'Technical & Commercial' > 'Working on Roads.'

3. AUTHORITY TO ERECT TRAFFIC CONTROL DEVICES

3.1 MAIN ROADS

The Commissioner of Main Roads (CMR) has authority under the Road Traffic Code, to erect, establish or display and alter or take down any road sign or traffic control signal (subsequently referred to herein as 'to utilise traffic signs and devices'). The CMR has delegated specified officers of Main Roads to administer the utilisation of traffic signs and devices in accordance with the Main Roads Delegation of Authority Manual.

3.2 MAIN ROADS AGENTS

Main Roads agents or contractors shall, subject first to the approval of their Main Roads Contract Manager, utilise traffic signs and devices in accordance with this Code for the purpose of managing traffic at works on roads. Main Roads Contract Managers will comply with the Main Roads Delegation of Authority Manual in regard to providing such approvals.

3.3 AUTHORISED BODIES AND THEIR AGENTS

The CMR authorises Authorised Bodies and their agents, in accordance with the provisions of the Road Traffic Code, to utilise traffic signs and devices subject to any conditions attached to their Instrument of Authorisation. An example of a typical 'authorisation' is contained in Appendix 3.

A register of Authorised Bodies is available on Main Roads website at www.mainroads.wa.gov.au; go to 'Technical and Commercial' > 'Working on Roads' > 'Authorised Agreements.'

3.4 OTHERS NOT PARTY TO AN INSTRUMENT OF AUTHORISATION

Others that are not party to an Instrument of Authorisation but need to utilise traffic signs and devices for the purpose of managing traffic for works on a road, shall first contact the Authority responsible for the care, control and management of the road to confirm their requirements.

If the Authority responsible for the care, control and management of the road is an Authorised Body, it will determine the requirements and approval process for others not party to an Instrument of Authorisation. Unless advised otherwise by such Authority, the responsibility for ensuring signs and devices are erected and maintained in accordance with this Code will, at all times, remain with the party undertaking the works.

If the Authority responsible for the care, control and management of the road is not an Authorised Body, authority to utilise traffic signs and devices either by such Authority itself, its agents or contractors or, by a third party, shall be obtained from Main Roads with the concurrence of such Authority.

3.5 AUTHORISING TRAFFIC MANAGEMENT PLANS

General Requirements

Table 5.3 of AGTTM Part 8 details the responsibilities of the Road Infrastructure Manager, stating they are responsible for:

- ensuring that all TTM measures are in accordance with Jurisdictional requirements, AS1742.3 and the AGTTM.

This refers to the general responsibility of Road Infrastructure Managers to undertake a high level check of the proposed traffic management focussing on any issues that may present a safety or operational risk to the road network at the particular location. The Road Authority or Road Infrastructure Manager is not responsible for ensuring every aspect of the TMP is compliant with all TTM requirements, as this is the responsibility of the TMP designer, the person who checks the TMP (from the traffic management company) and the Roadworks Traffic Manager (RTM) who reviews and endorses (if applicable) the TMP to ensure that the plan is compliant with all TTM requirements.

The Road Authority has a duty of care to the safety of road users and road workers within their jurisdiction, and as a result they should conduct a review that focuses on the TMP's suitability in catering for all road users, speed zone appropriateness, traffic efficiency and ensuring after care and staging Traffic Guidance Schemes (TGS) are provided. The Suitability Check checklist may assist officers within the road authority fulfil this obligation (see section 5.1.3).

By signing the 'Road Authority Authorisation' section of a Traffic Management Plan (TMP) the Road Authority (Main Roads and/or LGA) is endorsing the implementation of temporary traffic management on that road.

Traffic Management on Roads Controlled by Main Roads

Main Roads, or Main Roads contractors with an Instrument of Authorisation, shall review and authorise the plan as per the general requirements above.

Traffic Management on Local Government Roads

The Local Government Authority shall review and authorise the plan as per the general requirements section above.

At permanent traffic signals on local government roads Main Roads will review and authorise the required changes to the Main Roads Traffic Signals only (see the [Temporary Traffic Management: Traffic Signal Approval Policy](#)). Additionally, where works are on local government roads, but it is identified that there may be an impact to nearby roads that are controlled by Main Roads, then Main Roads shall review and authorise the TMP as per the general requirements section above.

4. PLANNING THE WORKS

4.1 DUTY OF CARE

Any Person Conducting a Business or Undertaking (PCBU) in connection with or pursuant to temporary traffic management or any works on a road, has a 'duty of care', so far as is reasonably practicable, that the health and safety of workers who work for the PCBU or whose activities in carrying out work are influenced or directed by the PCBU, are not exposed to health and safety risks arising from that business or undertaking.

A PCBU shall ensure, so far as reasonably practicable, that other road users are not exposed to health and safety risks arising from any TTM business or undertaking.

A PCBU includes all types of working arrangements such as crown agencies, organisations, companies, principals, contractors and sub-contractors.

The Occupational Safety and Health Act specifically requires:

- An employer to provide a safe place of work for its employees and
- Any person in control of a workplace, to take measures to ensure persons who have access to that workplace (including road users in case of a roadworks site) are not exposed to hazards.

4.2 TRAFFIC MANAGEMENT PLANS

4.2.1 General

Any party undertaking work on a road shall prepare a Traffic Management Plan (TMP) that adequately provides for the safety of workers and road users while maintaining an adequate level of service to road users. Traffic management planning should be undertaken in accordance with the AGTTM Part 2: Traffic Management Planning.

To ensure a consistent approach is taken when developing a TMP one of the Main Roads TMP templates¹ (see [here](#)) shall be used as a basis for the development of the plan. Any section headings that are not applicable to the TMP being developed shall be kept in the document and noted as not applicable (with the intent of keeping the TMP section numbers the same throughout all TMPs).

All TMPs shall be prepared by a person holding Main Roads accreditation in Advanced Worksite Traffic Management (AWTM). A person holding Main Roads accreditation in Worksite Traffic Management (WTM) may make on-site adjustments to the TMP in accordance with its scope and objectives (following any adjustment the residual risk shall not be higher to workers or road users). Further information regarding requirements for WTM / AWTM tasks and accreditation is provided in section 8.

TMPs shall be signed by the person that prepared them, along with their name in block print, AWTM certificate number and the date of endorsement of the plan. In addition, the person preparing a TMP shall also include a statement on the plan confirming that a site visit² was undertaken by them or another person under their direction, prior to preparing the plan (not required for Generic TMPs, see 4.2.2).

¹ Note: the basic TMP template may be used when conditions in the Basic TMP checklist (section 5) are met. Go to www.mainroads.wa.gov.au > 'Technical & Commercial' > 'Working on Roads'

² It is good practice to include photographs as evidence that the site visit was undertaken.

With the exception of repositioning of traffic control devices within the allowable tolerances specified in AGTTM, where any on-site changes to a TMP are proposed, such changes shall be endorsed by a person holding current WTM or AWTM accreditation. A copy of all documentation relating to the endorsement of the changes shall be held on-site by the person managing the works.

All TMPs must contain a contingency plan for fatality and serious injuries which must detail arrangements for preserving the worksite. See section 7.6 of AGTTM Part 6.

All Traffic Guidance Schemes (TGSs) shall be signed and dated by the person that prepared the TMP and be appropriately labelled so that those implementing the TGSs implement the correct Traffic Management for the particular work situation (Labelling example: 'when clearance to traffic is less than 1.2 m'). It is recommended that all Site Specific TGSs contain the days and times the TGS is to be implemented.

Where a TMP is to be used on more than one occasion or at a number of generic locations, continuous improvement must be considered. This will ensure the quality of traffic management is maintained or improved where required. The process should include debrief meetings to discuss any issues or risks associated with the plan. TMPs must be kept up to date considering changes in: traffic volumes, vehicle types, the road environment, work practices, legislation and/or standards. As a minimum, TMPs should be reviewed at least once in any 12-month period.

4.2.2 Generic TMPs

For routine/repetitive type works such as minor pavement maintenance, a generic TMP may be appropriate. The person preparing the TMP shall refer to the [Generic/Site Specific TMP Checklist](#) to assist in determining whether the traffic management setup can use a generic or site specific TMP, this is available on the Main Roads website www.mainroads.wa.gov.au ; go to 'Technical & Commercial' > 'Working on Roads.'

For Generic TMPs a site visit by the AWTM that prepared the TMP³ is not required, however the person responsible for implementing the TMP shall be aware of the scope of situations covered in the TMP and ensure it is applicable for the site⁴. The person implementing the TMP shall complete the Generic/Site specific TMP checklist, see below process for TGS selection. Where the generic TMP is not a suitable a site specific TMP shall be developed.

Process for TGS Selection

Generally, Generic TMPs will contain Generic TGSs with no specific location information and may be applicable for use at a number of locations. It is recommended a selection procedure is defined within the TMP to assist the onsite BWTM in the selection of the correct TGS for the road type, road environment and the type and location of works to be undertaken (for example on shoulder or in lane). An example TGS selection checklist is located on the Main Roads website, see [here](#).

A TGS is defined as 'Site Suitable' once a Generic TGS has been selected using the defined selection procedure, a site visit or investigation of the site is conducted, and it has been confirmed that the selected TGS is appropriate for use for the works at that site.

³ RTMs may endorse Generic TMPs that do not involve 'complex traffic arrangements' without undertaking a site visit, see section 4.2.3.

⁴ The TMP shall be authorised for implementation by the relevant road authority, see section 3.

All Generic TGS shall be confirmed as a Site Suitable TGS prior to commencement of works. Once the Generic TGS is confirmed as suitable for use, location information is added to the Generic TGS. Confirmation that a Generic TGS is site suitable shall be performed and signed off by a BWTM, WTM or AWTM, details shall be recorded in the daily diary.

4.2.3 Traffic Management Plans Involving ‘Complex Traffic Arrangements’

‘Complex traffic management arrangements’ are those activities and traffic management arrangements that include any of the following:

- i. Any plan assessed as having a residual risk-rating of H (high-risk) or greater as a result of a risk assessment undertaken during the planning stage.
- ii. Any plan that meets all the following:
 1. Occurs on a multilane road in the metropolitan area; and
 2. Closes or diverts one or more lanes (includes emergency lanes); and
 3. Occurs on any Freeway OR road with a permanent speed limit of 90 km/h or more (or a section of these roads where the speed limit is reduced due to traffic signals); and
 4. Has a traffic volume of 15,000 vpd or more.
- iii. Any plan at permanent traffic signals that requires:
 1. Alteration to the function of the traffic signals or signal display (e.g. flashing yellow, masking displays, modifying movements or phasing); or
 2. Closure of a traffic lane (including tapers or road closures):
 - a. within a signalised intersection, or
 - b. within 30 m of the stop line on the approach, or
 - c. within 30 m of the adjacent stop line on the departure, or
 3. Closure of any part of a signalised dedicated turning lane;

See the [Temporary Traffic Management: Traffic Signal Policy](#) for more details.
- iv. Any Traffic Management arrangement involving Temporary Road Safety Barriers.
- v. Any plan that involves the removal or replacement of permanent road safety barriers that are preventing a potentially catastrophic outcome, e.g. commuter rail or freeway barriers.
- vi. Temporary diversion of traffic into the opposite lane of a multilane road creating a free flowing contra-flow situation (does not apply to contraflow implemented at overtaking lanes).
- vii. Plans that will redistribute traffic, significantly lowering the level of service and safety of the surrounding road network, including isolated intersections.
- viii. Any other situation where the road authority or authorised body consider the traffic arrangement sufficiently complex to warrant RTM review and endorsement.

TMPs for works involving ‘complex traffic arrangements’ shall be reviewed and endorsed by a Roadworks Traffic Manager (RTM) in the form of their signature, the date, block printed name and RTM accreditation number. Further information regarding requirements for RTM accreditation is provided in section 8.

TMPs for works involving ‘complex traffic arrangements’ that have been prepared by a person holding RTM accreditation shall be reviewed and endorsed by another person with RTM accreditation.

RTMs shall only endorse finalised Traffic Management Plans⁵ that include a documented risk assessment of the proposed works in accordance with Section 4.3 and Appendix 2 of this Code, during the planning stage. A TMP shall not contain a residual risk rating VH (very high-risk) for any proposed traffic management treatment. A TMP involving a residual risk rating H (high-risk)⁶ shall be reviewed and endorsed by an RTM.

Regardless of whether a particular TMP involves 'complex traffic arrangements' or not, the Road Authority/Authorised Body that grants approval for the works to proceed may determine that the TMP requires to be endorsed by an RTM.

With the exception of repositioning of traffic control devices within the allowable tolerances specified in AGTTM, where any on-site changes to a TMP involving 'complex traffic arrangements' as determined in the planning stage are proposed, such changes shall be subject to a risk assessment using the same methodology documented in the TMP (unless an alternative methodology has been specified in the TMP). The risk assessment shall be undertaken by a person holding current Worksite Traffic Management or Advanced Worksite Traffic Management accreditation. These changes shall be within the scope and objectives of the TMP, anything outside this will need to be endorsed by the RTM and authorised by the relevant road authority.

A copy of all documentation relating to the risk assessment shall be held on-site by the person managing the works. Additionally, following the on-site implementation of the changes, a copy of this documentation shall be referred back to the Roadworks Traffic Manager that endorsed the design of 'complex traffic arrangements', as soon as practicable for review and feedback to the person/contractor managing the works.

Roadworks Traffic Managers must abide by the Code of Conduct in discharging their professional duties at all times. The [Code of Conduct for Roadworks Traffic Managers](#) is available on Main Roads website at www.mainroads.wa.gov.au; go to 'Technical and Commercial' > 'Working on Roads' > 'Training and Accreditation'

As per the RTM Code of Conduct, RTMs are required to make at least one site visit prior to endorsing a site specific⁷ Traffic Management Plan. However, in regional areas that do not have access to RTMs based within 200km of the site, RTMs may endorse complex TMPs without the need to undertake a site visit when all the following criteria is met:

- The works associated with the TMP will be completed in less than 5 shifts (5 days).
- The TMP does not include any risks that have a residual risk rating of High or greater,
- The TMP does not involve Temporary Road Safety Barriers,
- A person with AWTM accreditation undertakes a site visit after they have consulted with the RTM to determine what information is required (video, photos, measurements, etc.).

It is important that the RTM collects and maintains photographic and video evidence provided by the AWTM undertaking the site visit. Regardless of the above, a Road Authority / Authorised Body reserves the right to request that an RTM undertakes a site visit in person, in accordance with the RTM Code of Conduct.

⁵ The endorsement shall be of the entire TMP not just the parts that are considered 'complex'

⁶ Traffic flow may be exempted, traffic flow less than 135 % of the allowable capacity as detailed in AGTTM Part 3 may be endorsed by a person with AWTM accreditation as part of a variation to standards form, see section 4.5.

⁷ Site visit not required for Generic TMPs

4.2.4 Temporary Road Safety Barrier Detail in TMPs

As required in section 4.2.3 of this code any TMP involving Temporary Road Safety Barriers shall be reviewed and endorsed by an RTM. It is the responsibility of the RTM to ensure the TMP contains adequate barrier detail. Where temporary barriers are required these shall be designed in accordance with manufacturer's requirements, Austroads and Main Roads technical guidelines. Calculations shall be appended to the TMP.

TGSs shall provide sufficient detail so that installers can determine offset from traffic lanes, worksite length/width, deflection distances required, containment fences (if required), start and finish points of the barrier, flare rates (if any) and necessary end treatments. Temporary barriers must be rated at the appropriate test level and be an approved barrier type listed on the Main Roads Website (Go to www.mainroads.wa.gov.au 'Technical & Commercial' > 'Technical Library' > 'Road & Traffic Engineering' > 'Roadside Items' > 'List of Approved Road Safety Barrier Systems').

Where temporary barriers are required, implementation methods should be detailed in the TMP and TGSs should be prepared.

4.2.5 Traffic Management Implementation and Removal

The implementation, operation and/or removal of the temporary traffic management shall be considered part of the works, therefore the TMP shall provide details on how this activity will be conducted safely (refer to AGTTM Part 5 and Part 6) including order of set up and pack down. This may require an additional TGS for the traffic management personnel to follow. The following shall be considered:

- The requirement to install and remove traffic management devices in the sequence described in AGTTM Part 6
- Use of shadow vehicle for protection, note a shadow vehicle is only considered a shadow vehicle if it is protecting workers
- Use of a look-out person when workers are no longer protected by the shadow vehicle e.g. crossing the road or unloading the vehicle
- A Truck Mounted Attenuator may be required to protect workers
- Traffic control may be required to safely implement a lane closure or lateral shift.
- Lane closures or traffic control may be required when installing temporary pavement marking or devices, such as barriers.

Note: it is still the responsibility of the person undertaking the traffic management activities to be familiar with the relevant requirements detailed in AGTTM Parts 5 and 6; contents of the TMP, including TMP risk assessment, and to ensure a thorough risk assessment, e.g. Safe Work Method Statement (SWMS), has been prepared that covers all site-specific risks, implemented controls for the task and this is communicated and understood by all the traffic management crew.

4.3 RISK MANAGEMENT

Management of risk is central to a TMP.

The risk management process for the planning of the works shall be in accordance with AGTTM Part 2: Traffic Management Planning and Appendix 2 of this Code and included within the TMP.

The risk management process is applicable at all levels of planning, design and operation, refer to the AGTTM series for additional guidance.

The following must be considered when undertaking the risk management process for any activities on or near roads:

- the Occupational Safety and Health Regulations 1996 identify construction work on or near roads as high risk construction work,
- AGTTM indicates that all works on roads are considered high risk,
- Main Roads has corporately identified interaction with live traffic as a critical risk.

Taking this into account it would usually be expected that the pre-treatment risk ratings for works (including traffic management set up and pack down⁸) near live traffic would have a pre-treatment risk rating of high or greater, i.e. it is recognised that it is possible that workers may suffer major injuries or severe permanent disablement when working near traffic with no treatments or controls in place (e.g. engineering, administrative, PPE, etc.). Ensure current MRWA risk classification table is used and the alphanumeric codes from Table A2-4 are included as per the example below.

Example pre-treatment risk rating (note this is the risk rating with no controls in place):

Risk Event	Consequence	Pre-treatment Risk		
		Likelihood	Consequence	Risk Rating
Distracted or impaired motorist may crash into workers setting up the traffic management.	Serious injury to workers.	Likely (B)	Major (4)	Very High (16)

AGTTM Part 10: Supporting Guidance provides specific guidance on the risk management process for temporary traffic management, this is generally supported in WA however the tables in appendix 2 of this code should be used for:

- consequence / impact (Table A2-1 and A2-2),
- measures of likelihood (Table A2-3),
- risk rating matrix (Table A2-4), and
- treatment / management approach (table A2-5).

4.4 CONSULTATION, COMMUNICATION AND NOTIFICATION OF ROADWORKS

Roadworks have the potential to cause significant delays or access problems, or create adverse impacts on existing road infrastructure such as traffic signals, railway crossings, bridges, etc. Stakeholder consultation and/or communication is an essential part of preparing a TMP. For example, the relocation or diverting of traffic using lane closures or detours can change loading dynamics or introduce additional loadings on nearby bridges to the extent that bridge capacities and load restrictions may be exceeded.

It is important that where traffic is to be detoured via an existing road network, the road authority responsible for roads forming the detour is notified of the traffic arrangements during the planning of the works, i.e. when preparing the Traffic Management Plan (see section 4.2).

It is the responsibility of the individual or organisation proposing to undertake works to ensure all relevant stakeholders are appropriately notified of the works and subsequent impacts on traffic conditions.

⁸ Risk rating must be included in the TMP for traffic management set up and pack down.

4.4.1 Consultation

Consultation is an essential part of the preparation of a TMP, including consultation with the road authority. It is also important to consult with any stakeholders who have an understanding of site features and constraints, and who will be impacted by the implementation of the traffic management plan. Examples of stakeholders to be consulted include:

- road authorities
- residents and landowners
- local businesses
- schools
- public transport providers
- road infrastructure managers

Transperth

If planned road works are impacting Transperth bus services or bus stops* approval must be obtained from a member of the Transperth Service Disruption Team (Transperth.ServiceDisruptions@pta.wa.gov.au) ensuring they are satisfied with proposed detours and bus stop closure or relocations. The PTA will require a minimum of 5 working days' notice to review any plans or traffic guidance schemes. A TGS indicating the bus detour and/or bus stop relocations shall be provided.

** Transperth approval is not required for any roadworks occurring on residential streets for a short duration (less than two hours and outside of peak times); however, they will still require of Notification of Roadworks form.*

Children's Crossings and School Zones

Children's crossings in Western Australia are installed under the approval of a State Government appointed committee known as the Children's Crossings and Road Safety Committee. Once approved, Main Roads and the relevant local government install children's crossing infrastructure to strict guidelines. Unless in an emergency, under no circumstance shall a children's crossing be closed, moved or interfered with for the purpose of any works without seeking advice from the Children's Crossing and Road Safety Committee via the Western Australia Police Children's Crossing Unit.

Where works are located within a School Zone, consideration shall be given to undertake the works outside the period indicated on the school zone sign or in school holidays. Where this cannot be done OR where a children's crossing is located within a roadwork's site, the following actions shall be taken:

- Consult with the Western Australian Police Children's Crossing Unit at the planning stage to agree on and finalise arrangements for the safe passage of school children and pedestrians.
- Ensure the speed shown on the temporary speed zone and termination signage is less than or equal to the speed shown on the school zone sign during the school zone operating times. In cases where the worksite extends beyond the school zone, termination signage shall reflect the posted speed applicable to that section of road.
- Where the children's crossing stop line and side bollard have been removed as part of the roadworks, traffic controllers shall be positioned at the location of the children's crossing stop line(s) to guide vehicles where to stop on the approach side of the children's crossing.

- Where roadworks alters normal traffic paths during the operating times of a children's crossing, traffic controllers shall assist the Traffic Warden to control vehicles and pedestrians at the children's crossing as required. If a Traffic Warden is not available, the crossing cannot be managed as a children's crossing. However, Main Roads accredited traffic controllers may be utilised to ensure the safe operation of the crossing in the same manner as other priority pedestrian crossings are temporarily managed.
- Provisions for pedestrian and bicycle facilities shall be in accordance with AGTTM.

Railway Crossings (Including Crossings without Flashing Signals)

Any works within the distances from a railway level crossing given in Table 3 and are likely to result in realignment of a road section or intersection impacting on the railway level crossing or significantly affecting the existing traffic flow through a railway level crossing, the relevant Rail Infrastructure Manager shall be notified at least two (2) weeks prior to the works by the party arranging the works. The Rail Infrastructure Manager may determine a Rail Safety Management Plan (RSMP) is required for roadworks which impact on the safe operation of the railway.

Speed limit (km/h)	Distance from railway (m)
<70	150
70 to 90	200
>90	300

Table 3 - Distances from railway level crossings where significantly impacting crossing

Traffic Controllers need to be aware that motorists will generally follow their directions when they differ from other signals, signs and devices on the road. They need to take special care at railway crossings to ensure they do not direct traffic through signals requiring vehicles to stop, unless it is clearly safe for vehicles to proceed through them.

Where a railway level crossing exists within a section being controlled by a Traffic Controller, a flag person with the relevant Track Access Permit should be stationed at the traffic stop line of the railway crossing at least 3m from the nearest rail, equipped with a two way radio, to watch for trains and advise the Traffic Controllers to stop traffic in time for train movements through the level crossing.

The flag person should make sure that the relevant Rail Infrastructure Manager has been notified before he/she commences work. On each day, prior to the commencement of works, the Rail Infrastructure Manager should be advised of the works that will be proceeding on that day, so that train drivers can be warned of the works and advice can be received on the times that trains are expected to use the crossing (this will be determined by the relevant Rail Infrastructure Manager).

If the section of road under traffic control is to one side of the railway level crossing, but within the distances in Table 3, the flag person stationed at the railway level crossing shall be stationed on the same side of the crossing as the section under traffic control, at the traffic stop line or at least 3 m from the nearest rail. The flag person stationed at the railway level crossing shall be equipped with a hand-held STOP/SLOW sign that has the rear 'SLOW' sign covered. This is to prevent vehicles approaching the other side of the railway level crossing following the SLOW instruction and ignoring other signs or flashing signals.

Traffic Controllers shall also ensure that vehicles stopped do not queue back over a railway level crossing. If there is a chance of this happening, vehicles should be stopped prior to the railway level crossing.

Refer to the [Railway Crossing Control in Western Australia Policy and Guidelines](#) on the Main Roads website at www.mainroads.wa.gov.au > 'Technical & Commercial' > 'Technical Library' > 'Traffic Management' > 'Railway Crossing Control'

4.4.2 Notification of Approved Roadworks

Notification of approved Roadworks shall be sent using the form in Appendix 4 at least seven (7) days prior to works commencing, in the following situations.

Note: the notification form does not replace the need to consult with relevant stakeholders.

(a 'Word' document version of the [Notification of Roadworks Form](#) is available on Main Roads website at www.mainroads.wa.gov.au; go to 'Technical & Commercial' > 'Working on Roads'.)

There may be other stakeholders that require notification that aren't listed. Only stakeholders impacted should be sent the form:

- Works involving the complete closure of any road (may not apply to access roads, however residents shall be notified).
- Works on primary and district distributor roads of more than four (4) hours duration where it is expected that traffic delays and congestion will occur.
- Traffic management activities involving the establishment of a contra-flow.
- Traffic management activities resulting in any direct or indirect changes to traffic flows and/or traffic composition on bridges, including situations where such changes are a result of lane closures or traffic detours.
- Works on any primary or district distributor road where construction activities will make it difficult or impossible for the passage of general access or oversize vehicles, and traffic control devices cannot be easily shifted on a temporary basis to allow the vehicle to pass.
- Traffic management activities that prohibit turning movements at signalised intersections.
- Works occurring through any Traffic Warden controlled children's crossing.
- Any other activities where major impact on stakeholders are expected.

It is essential that the relevant road authority is informed of all communications or notifications planned and/or executed to support the implementation of traffic management.

For all works requiring the complete or partial closure of a road, an outline of the planned communications should accompany the Notification of Roadworks form. Where applicable, contact details for the communications coordinator (or equivalent) should also be provided.

4.5 VARIATION TO THE CODE, AGTTM AND STANDARDS

Where compliance to this Code or the requirements of AS1742.3 or AGTTM cannot be satisfied e.g. due to the physical road environment (i.e. a building or fence close to the road or minimal existing road width), legislative constraints (i.e. environmental, cultural or heritage constraints), etc., a variation to this Code or standards will be required. Approval for the variation shall be obtained from each relevant Road Authority responsible for the care and control of the road on which the placement of traffic control take place.

Before seeking the Road Authority's approval, it is imperative that a risk analysis of the variation be carried out. Where the variations result in a traffic management treatment of lesser standard, it shall be based on a risk assessment undertaken by a Roadworks Traffic Manager (see section 4.3). The details of the risk assessment process shall be documented in the Traffic Management Plan with RTM endorsement in the form of their signature, the date, block printed name and RTM accreditation number.

A person with Advanced Worksite Traffic Management (AWTM) accreditation is permitted to endorse a traffic management plan where vehicles per hour are less than 135% of the allowable traffic volume detailed in the desirable traffic lanes and the maximum length of single lane operation within AGTTM Part 2 and 3 (i.e. RTM endorsement is not required). This shall still be treated as a variation to standard, with risk assessment process completed by the AWTM, as outlined above. Vehicles per hour equal to or greater than 135% of allowable traffic volume will require a variation to standard with RTM endorsement. Approval for any variation shall be obtained from the relevant Road Authority.

A risk assessment shall also be carried out if any party considers that additional measures above and beyond the minimum requirements of the Code are necessary. Where the local road authority had not been granted an Instrument of Authorisation, pursuant to Regulation 297(2) of the Road Traffic Code 2000 relating to Traffic Management for Roadworks, approval shall be obtained from Main Roads.

For activities undertaken on a state road or on behalf of Main Roads, the approval for the variation shall be obtained from the appropriate Main Roads Officer using the [Variation to Standards Application Form](#) available from the Main Roads website www.mainroads.wa.gov.au; go to 'Technical & Commercial > 'Working on Roads'

The approved variation form or a letter from the local road authority approving the variation shall be provided as an attached supplement to the traffic management plan.

5. REVIEW, INSPECTION, ROAD SAFETY AUDIT AND OPERATION

5.1 REVIEW, INSPECTION AND ROAD SAFETY AUDIT

AGTTM Part 10: Supporting Guidance section 3 provides requirements for conducting reviews, inspections and road safety audits at temporary traffic management. WA has the below variations and additions to AGTTM.

5.1.1 Audits

Generally, in WA rather than Senior Road Safety Auditors conducting Roadworks TMP and TGS design phase road safety audits, Roadworks Traffic Managers (RTM) conduct the below Temporary Traffic Management audits (the RTM may also be a Senior Road Safety Auditor).

Suitability Audit

A Suitability Audit is a systematic and independent examination of the extent to which the proposed Traffic Management Plan addresses specified requirements and provides a measure of the project's capability in meeting those requirements. This audit is conducted by an RTM prior to the implementation of the TMP. The RTM:

- audits the entire TMP and all TGSs;
- audits against contractual requirements;
- considers all safety issues related to the traffic management including crash risks;
- considers traffic flow and efficiency;
- inspects the site;
- writes an audit report, see template [here](#);
- holds a completion meeting with relevant site personnel, e.g. project manager, traffic manager, etc.

Compliance Audit

A Compliance Audit is a systematic and independent examination of the extent to which a project fulfils its traffic management requirements (including the Traffic Management Plan) and provides a measure of the project's performance in meeting specified requirements. This audit is conducted by an RTM after a TMP/TGS has been implemented and may be conducted at various stages of the project. The RTM:

- audits the entire TMP and all TGSs (may only be able to cover off the implementation of the TGS in place at the time of the audit);
- audits against contractual requirements;
- considers all safety issues related to the traffic management including crash risks;
- considers traffic flow and efficiency;
- inspects the site;
- writes an audit report, see template [here](#);
- holds a completion meeting with relevant site personnel, e.g. project manager, traffic manager, etc.

5.1.2 Suitability Reviews and Compliance Safety Inspections

Refer to AGTTM Part 10 (sections 3.3.1 and 3.3.2) for details on Suitability Reviews and Compliance Safety Inspections. These have the same requirements as those listed in the Suitability/Compliance audits above except these are conducted by a person with AWTM accreditation and a full report does not have to be produced (can also be undertaken by an RTM).

Note: Site supervisor compliance (operational) safety inspections, as described in section 3.3.2 of AGTTM Part 10, may be conducted by a person that does not hold AWTM accreditation.

5.1.3 Suitability Check

A suitability check is a check of the traffic management plan to ensure it addresses the specified requirements of the works, all types of traffic and the road environment. This includes a check of compliance with standards and the identification and mitigation of all site specific and operational risks.

This check ensures the TMP is appropriate prior to being implemented.

- Conducted by AWTM or WTM (or person within road authority with equivalent level of knowledge and experience).
- Conducted prior to implementation.
- Does not require a report to be written.
- Desktop check that does not require a site visit.

Note: it is good practice for traffic planners to have someone undertake this type of check before submitting the TMP to the road authority.

5.1.4 Review and Audit Checklists

Checklists have been developed to assist personnel to prepare, review, audit, approve and / or authorise traffic management plans. The checklists are located on the Main Roads website at www.mainroads.wa.gov.au: 'Technical & Commercial' > 'Working on Roads'

5.2 TRAFFIC MANAGEMENT OPERATION AND RECORDS

It is a requirement that any party undertaking work on or alongside a road, shall keep a copy of the current approved TMP onsite. Daily records of the sign arrangement or traffic guidance scheme shall be kept in a diary in accordance with AGTTM Part 6: Field Staff – Implementation. As a minimum, the Daily Diary shall be based on the Daily Diary Template on the Main Roads website www.mainroads.wa.gov.au; go to Technical & Commercial' > 'Working on Roads'

Due to the availability of smart phones and video cameras, when conducting workplace inspections and/or altering the traffic guidance scheme, video evidence should be considered (to support written documented records).

Claims for damages are often made a considerable time after an incident. Under the Limitation Act (WA), claims for negligence must be commenced within six (6) years. However, a defendant may be unaware that an action has commenced for a further year as the plaintiff has this time in which to serve the writ.

Main Roads recommends that traffic management records be securely stored for a period of not less than seven (7) years from the date of completion of the works. The Authorised Body that grants approval to a Traffic Management Plan should keep a copy of the approved Traffic Management Plan and any daily records of their supervisory staff that capture the on-going implementation of the Traffic Management Plan.

In case of all works undertaken for or on behalf of Main Roads, the persons arranging the traffic management works shall keep their own daily records in addition to a copy of the approved TMP together with any other relevant records.

For all other works the requirements for record keeping in relation to traffic management shall be determined by the Authorised Body responsible for or authorising the work.

6. DEPARTURES FROM DESIGN REQUIRMENTS IN AS1742.3 AND AGTTM

The following departures to the requirements of AS 1742.3, AGTTM and other additional requirements are to be applied to temporary traffic management in Western Australia.

6.1 TEMPORARY SIGNAGE

6.1.1 General

Any roadworks signage that is not within the AS 1742 series needs to be approved by Main Roads before it can be implemented on the road network. All Main Roads approved signage is on the Main Roads website at www.mainroads.wa.gov.au; go to 'Technical & Commercial' > 'Technical Library' > 'Signs Index'. Warning and regulatory signs should not be altered or modified; particularly regulatory signs which may become unenforceable.

Any new signs in AS1742.3-2019 cannot be adopted in WA until the sign specifications are added to AS1743 Road signs – Specifications. Main Roads signs with sign numbers and specifications should continue to be used.

The signs must be sourced from an approved sign maker. This ensures the sign sheeting materials are in accordance with the required standards. The list of approved manufacturers is available in Specifications 601 – Signs, which can be found on the Main Roads website www.mainroads.wa.gov.au ('Technical & Commercial' > 'Technical Library') refer to Annexure 601 I 'Sign Makers Accredited by Retroreflective Sheeting Manufacturers'.

Note: Australian Standard or Main Roads signs usually used for permanent installation may be used at temporary traffic management sites as appropriate.

6.1.2 REDUCE SPEED Signs

The REDUCE SPEED sign should be used at worksites with a posted speed limit greater than 60 km/h when reducing the speed by 30 km/h or more.

The signs should be placed on both sides of the carriageway, in advance of the lowest speed zone at the worksite. Distances prior to the sign and the temporary speed limit are provided in the table below.

Speed of Traffic 200 m prior to sign (km/h)	Distance (m)
60 or less	25
70 - 110	Half the traffic speed (km/h)

Table 4 – REDUCE SPEED sign spacing

When used in conjunction with a temporary speed limit sign in a multi-message sign arrangement, the REDUCE SPEED panel should be placed within the same multi message frame.



G9-9

6.1.3 NEW WORK NO LINES MARKED Signing

The NEW WORK NO LINES MARKED signs (T3-11, T3-12 and MMS-RC-3) are used to warn road users of the absence of line marking, see clause 4.9.3 of AS1742.3 – 2019.

Other than at an active work area these signs may be used without requiring the use of other advance warning signs (e.g. ROADWORK AHEAD), provided that the normal running lanes are not obstructed and there are no longer temporary roadside hazards at the worksite.



T3-11



T3-12

6.1.4 ROAD INSPECTION Sign

The below ROAD INSPECTION sign may be displayed on vehicles which are used for road inspections. The signs shall be located on the roof or rear of the vehicle and shall not obscure vehicle mounted warning devices.



MR-TVM-15

6.1.5 CYCLIST DISMOUNT Sign

Prior to undertaking any works that impact on bicycle paths this Code and AGTTM require these works to be planned to ensure cyclist safety whilst minimising disruption and inconvenience. Bicycle paths should be provided with the same scale and width as existing facilities. However, it is acknowledged that sometimes when conducting short term maintenance works on shared paths and bicycle paths it may not be practical to provide a surface that is suitable for all bicycles.

In the first instance other warning signs to warn riders of the surface condition and the need to reduce speed shall be displayed.

As a last resort, where cyclists cannot physically traverse the surface, the CYCLISTS DISMOUNT sign may be used. Therefore, any use of the CYCLIST DISMOUNT sign will only be for short durations and with the approval of the relevant road authority.

Note: The inappropriate use of this sign will result in riders failing to dismount where instructed.



MMS-PED-7

6.1.6 Pedestrian Warning Signs for Motorists

Along with the requirements detailed in section 3.8.3 of AGTTM Part 3 for contraflow arrangements, the use of the Pedestrian Warning sign (MR-TAW-31) may be used to provide warning to motorists at locations that have pedestrian crossings.



MR-TAW-31

6.1.7 Repeater Speed Restriction Signs

At locations where the A size speed restriction sign, R4-1A (450 x 600 mm), is permitted in AS1742.3, the MMS-REG-1 (600 x 600 mm) may be used as a standalone sign only when used as a repeater speed sign and if it is within a purpose made frame.

6.1.8 ROAD CLOSED and FOOTPATH CLOSED Signs

The ROAD CLOSED (T2-4, TM2-4B and TM2-4C) and FOOTPATH CLOSED (T8-4 and TM8-4A) signs in AS1742.3-2019 are black on white, however as these signs are yet to be added to AS1743 Road signs – Specifications, the black on yellow signs should continue to be used.

6.1.9 Sign Spacing

Where there is only a single advanced sign for approach speeds of 60 km/h or less, the sign may be positioned at the spacing shown in table 2.2 of AGTTM Part 3, i.e. the sign does not have to be double the spacing as required in section 2.5.3 of AGTTM Part 3. In the case of a single advanced sign for approach speeds of 70 km/h the sign shall be positioned at the spacing as per AGTTM Part 3 section 2.5.3 i.e. double the speed (km/h) = 140m.

6.2 GUIDELINES FOR MULTI-MESSAGE SIGNS

6.2.1 Introduction

Multi Message Signs (MMS) are included in AS1742.3-2019, however these signs have yet to be included in AS1743 Road signs – Specifications. Therefore, these signs cannot be adopted in WA and the Main Roads MMS sign numbers and specifications will be retained until AS1743 is updated.

6.2.2 Frames for Multi-Message Signs

See clause 4.5.2 of AS1742.3-2019. Further information on frame specifications can be found on the Main Roads website www.mainroads.wa.gov.au ('Technical & Commercial' > 'Technical Library') and Main Roads Specification 601 – Signs.

6.2.3 Substrates for Multi-Message Signs

A variety of different materials can be used for the sign substrates including the following:

- 5 mm core flute
- Aluminium
- UV stabilised plastic

The substrates for the signs shall be of sufficient thickness and rigidity to prevent the signs being blown out of the frame.

The signs must be sourced from an approved sign maker. This ensures the sign sheeting materials are in accordance with the required standards. The list of approved manufacturers is available in Specifications 601 – Signs, which can be found on the Main Roads website www.mainroads.wa.gov.au ('Technical & Commercial' > 'Technical Library') refer to Annexure 601 I 'Sign Makers Accredited by Retroreflective Sheeting Manufacturers'.

The rear of the sign substrate shall be non-reflective.

When using core flute multi-message signs at worksites where the signs will be operating both day and night or the signs will be left unattended, there shall be at least two (2) 5 mm thick core flute signs back-to-back in the multi-message frame to help prevent the sign from blowing out and /or sliding across (if back-to-back messages are not required the rear set of panels shall show the blank/rear plate).

6.3 SECURING SIGNS AND DEVICES

6.3.1 Securing Signs

AS 1742.3 indicates that signs and devices shall be positioned and erected so that they are properly displayed and securely mounted. The mountings should also be stable in windy conditions and from the effects of moving traffic. Signs shall have additional sign support and be located with adequate lateral clearance from the travelled way.

It is recommended that signs be mounted on permanent posts when works exceed 14 days duration, where permanent posts are proposed not to be used, a risk assessment shall first be undertaken to detail why they are not being installed and provide mitigation such as regular maintenance arrangements or additional supports.

Scenarios more likely to encounter fallen signs include but not limited to:

- Windy conditions are expected; or
- the road will be used by road trains, or
- The permanent speed is 80 km/h or greater.

The following options should be considered, using a risk management approach, to mitigate the risk of signs falling over and/or not being properly displayed:

- Permanent posts and mounting (in accordance with Main Roads specification 601)
- Semi-permanent mounting of permanent posts (in accordance with manufacturers specifications e.g. Oz Spike or similar)
- Affixing to other suitable permanent roadside infrastructure⁹
- Sandbags (or similar) weighing 10-15 kg on all 4 legs¹⁰
- Regular monitoring and maintenance in place to rectify fallen signs¹¹
- Use of Portable Variable Message Signs in advance of the work site

There may be a need to use a combination of the above methods on any particular site and some form of monitoring will always be required. For example, use of permanent posts for the ROADWORK AHEAD and initial speed reduction signs required for the entire duration of the project but temporary sign legs for the traffic control warning signs that need to be removed and/or relocated throughout the works.

The above mitigation shall be selected based on a risk assessment, noting more permanent mounting methods are more likely to reduce the risk of signs falling down however these risks need to be considered against the following:

- duration of the works,
- location of roadside services (e.g. dial before you dig),
- the sign message (e.g. signs that need to be covered, likelihood of incorrect messages being left up, consequence if the sign is not displayed),
- roadside environment (e.g. footpaths, driveways, etc.)

Note: Project / Contract Managers should ensure the above is considered in contract documentation, ensuring appropriate resources and personnel are provided for the required method of installation and monitoring.

⁹ Signs shall not be affixed to road safety barriers. If affixing to permanent sign posts ensure the permanent sign is covered or removed if required.

¹⁰ Where sign frames may be blown off the temporary legs a cleat or similar should be affixed to the outside of the edge of the sign approximately a quarter up from its base. Sufficiently weighted sandbags should then be attached to this with rope / string with some tension applied to the cleat.

¹¹ Some form of monitoring will always be required

6.3.2 Securing Cones and Bollards

When using cones or bollards at high-risk locations and it is expected they will blow over due to windy conditions, heavy vehicles or traffic speed, the following shall be considered to ensure additional stability:

- bollards to have a base of 12 kg (or two 6 kg bases can be used);
- cones be a minimum of 6 kg (or 3 kg cones can be doubled up, i.e. 2 stacked on top of each other).

Alternatively, bollards or cones can be fixed to the pavement (with approval from the road owner).

Examples of high-risk locations include lateral shifts on high speed roads, devices separating the work area, devices delineating excavations, etc.

6.4 COVERING EXISTING SIGNAGE AND ROAD MARKING

6.4.1 Existing Signs

In accordance with Clause 4.2.5 of AS 1742.3 - 2019 'Any signs and traffic control devices, including regulatory, warning guide signs and pavement marking, which are inappropriate to, or conflict with, the temporary worksite situation shall be covered, obliterated or removed'.

Where it is necessary to cover a sign face temporarily, caution must be exercised as some coverings will cause permanent damage to the sign face following exposure to moisture and sunlight e.g. plastic materials, especially black, is forbidden as it is known that these materials are responsible for severe and permanent damage within 24 hours.

Specifications for covering existing signage can be found in Main Roads [Specification 601 – Signs](#), located on the Main Roads website at www.mainroads.wa.gov.au; go to 'Technical & Commercial' > 'Tender Preparation' > 'Specifications' > '600 Series – Traffic Facilities'

6.4.2 Covering Regulatory Road Marking

In addition to the requirement to remove or cover regulatory devices that the TMP forces road users to contravene; it is recommended that regulatory road marking that portray a speed limit or traffic movement different to that shown in the TMP be covered.

Covering the road marking can be done with sticker products available from most sign makers. The colour of the sticker selected shall be similar to colour of the road surface. Long-term work sites should use the grinding and reinstatement method OR undertake routine inspection and maintenance on the stickers.

Where not possible to cover arrow pavement marking, lane status signs shall be provided that depict the permitted movements under the TGS.

6.5 SPEED LIMIT ZONES

6.5.1 Approval of Temporary Speed Limit Signs

Authorised bodies are permitted to erect temporary speed limit signs without approval from Main Roads. Where temporary speed limits other than 40 km/h, 60 km/h, or 80 km/h are necessary, prior approval from the relevant road authority under a variation shall be obtained. Unless the temporary speed results in a treatment being of a lesser standard, the variation can be completed by a person that holds AWTM accreditation.

All temporary speed limit signs on state roads shall be approved by Main Roads prior to their use, approval shall come from the authorised officer listed in section 13.1, Traffic Signs, of the Main Roads Delegation of Authority (note this applies to all traffic signs and devices).

6.5.2 Setting out Temporary Speed Zones (Buffer Zones)

This section has been prepared to provide additional guidance to section 5.5 of AGTTM Part 3 for designing temporary speed zones.

Main Roads requires the values (listed in Table 5) be used whenever temporary speed zones are required, unless a site specific hazard is identified and a risk assessment determines the need to extend the sign placement. This shall be documented in the risk assessment and response table of the TMP.

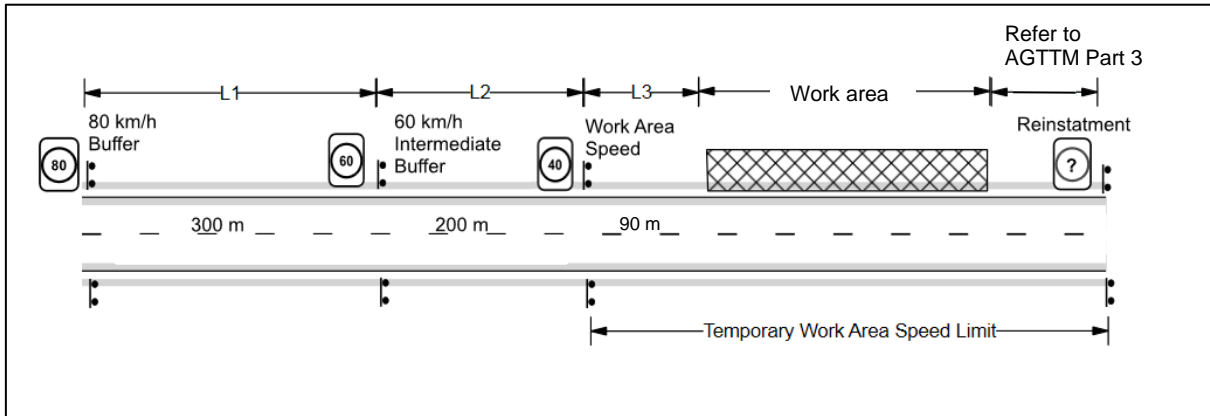

(a) Buffer zones – 110 km/h to 40 km/h

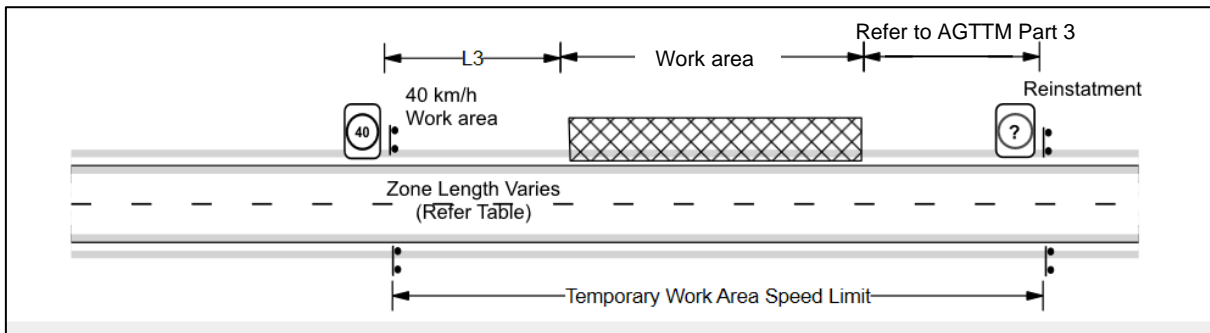

(b) No buffer zone required with 40 km/h work area speed limit (where posted speed limit less than 80 km/h).

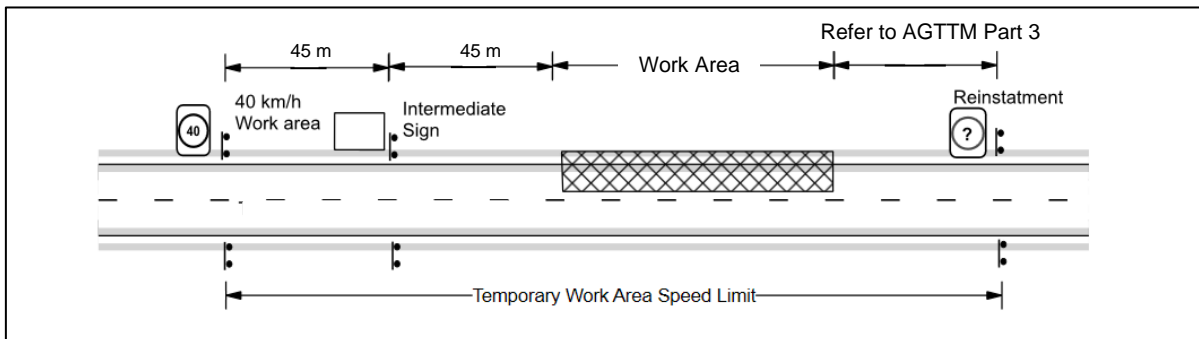

(c) L3 length extension due to intermediate advance signs (e.g. Prepare to Stop) – posted speed 60 km/h.

Notes:

1. Transition Area, e.g. safety buffer, taper, etc., may be within speed buffer prior to the work area speed limit;
2. Illustrations do not show all of the signs and devices that will be required at the worksite.
3. Refer to AGTTM Part 3 for details on the termination area

Figure 1: Temporary Speed Signs

Approach Speed (km/h)	Works Area Speed (km/h)	80 km/h Speed Buffer Required	L1 (80km/h buffer) (m)	L2 (60km/h buffer) (m)	L3 ¹² (m)
110	80	No	N/A	N/A	220
	60	Yes	300	N/A	160
	40	Yes	300	200	90
100	80	No	N/A	N/A	200
	60	Yes	300	N/A	160
	40	Yes	300	200	90
90	80	No	N/A	N/A	180
	60	No	N/A	N/A	180
	40	No	N/A	200	90
80	60	No	N/A	N/A	160
	40	No	N/A	200	90
70 ¹³	60	No	N/A	N/A	90
	40	No	N/A	N/A	90
60	40	No	N/A	N/A	45

Table 5 - Placement of temporary speed limit (buffer zone) signs¹⁴

Notes:

These spacings are required for the majority of scenarios. However, where a risk assessment determines that spacings need to be changed they shall be changed in line with AS1742.3 and AGTTM Part 3.

The table takes into account the requirement that the 60km/h speed zone length (L2) must not be less than 150m to ensure that adequate time is given to road users to adjust to the temporary speed zone before introducing an additional (lower) temporary speed limit.

To ensure uniformity and consistency a value of 200m for Zone Length (L2) and 300m for Zone Length (L1) has been adopted.

Where it is unsafe for the buffer speed zones to be applied (e.g. unsealed roads) 'speed limit ahead' signs shall be used in place of the buffer speed zones (see AGTTM Part 3).

The spacings shown in Table 3 have been applied within the Main Roads Generic Workzone Traffic Guidance Schemes on the Main Roads website at www.mainroads.wa.gov.au; go to 'Technical & Commercial' > Working on roads'

¹²Advanced warning signs placed within L3 may result in a longer L3 than is stated here.

¹³ The speed limit distance does not take into account the requirement for single advance warning signs to be placed at double the spacings shown in Table 2.2 of AGTTM part 3. If a single warning sign is implemented this must be placed at least 140 m in advance in accordance with AGTTM.

¹⁴ Advanced warning signs installed within zones shall be spaced in accordance with AGTTM. A safety buffer shall be provided in accordance with AGTTM.

6.6 TEMPORARY ROAD SAFETY BARRIER SYSTEMS

Section 5.3.1 of AGTTM Part 3 provides details on road safety barrier systems used at temporary traffic management sites.

The use, selection and location of temporary barriers should be in accordance with the [Main Roads Guide to the Design of Workzone Barriers](#), located on the Main Roads website at www.mainroads.wa.gov.au; go to 'Technical & Commercial' > 'Road & Traffic Engineering' > 'Roadside Items' > 'Guide to the Design of Workzone Barriers'

Only Main Roads approved road safety barrier systems shall be used; a list is located on the Main Roads website at www.mainroads.wa.gov.au; go to 'Technical & Commercial' > 'Road & Traffic Engineering' > 'Roadside Items' > 'Guide to the Design of Workzone Barriers' ['List of Approved Road Safety Barrier Systems'](#)

6.6.1 Delineation of Temporary Road Safety Barriers

Temporary Road Safety Barriers help protect road workers and road users from hazards, however the barriers themselves can also present a hazard to road users. Barriers must be adequately delineated with raised retroreflective pavement markers (RRPMs) complying with AS 1906.3 or temporary RRPMs (flaps) with retroreflective tape (class 1A minimum) to ensure road users are aware of their presence.

The Pavement Markers providing delineation shall be located on top of or on the traffic side of the barriers (< 300mm from the top), spaced at ≤12 m intervals along the barrier. Where used on curves with a radius up to 200 m the spacing shall be reduced to 6 m on the outside of the curve.

The retroreflector or tape may either be yellow double sided* on all barrier applications or the following colours may be used:

- a) Single sided red on barriers installed on the left hand shoulder or verge.
- b) Single sided yellow on barriers installed in the median of a divided road
- c) Double sided yellow where the barrier is positioned in between opposing direction of travel and delineator is placed on the top of the barrier
- d) Single sided white on barriers installed between lanes in the same direction of travel (rare scenario).

* The use of all yellow retroreflectors must be risk assessed prior to deployment, particularly on 2-way single carriageway applications.

Note: the above does not replace the need to provide temporary delineation of the travelled path in accordance with AS1742.3. This temporary barrier delineation is considered a replacement for guide post delineation where the location of the barrier is close enough to the edge of the road.

Temporary Pavement Markers Material Specifications:

- Extrusion. Polyurethane, 80 shore A
- Cover. PVC Flexible. Clear.

For further details on specifications for the adhesive and reflectivity properties of the Temporary Pavement Markers, see [Main Roads Specification 604](#), located on the Main Roads website at www.mainroads.wa.gov.au; go to 'Technical & Commercial' > 'Tender Preparation' > 'Specifications' > '600 Series – Traffic Facilities'

1. REFLECTIVE AREA OF THE TEMPORARY PAVEMENT MARKERS TO BE LOCATED PERPENDICULAR TO THE FACE OF WHICH THEY ARE APPLIED TO.
2. TEMPORARY PAVEMENT MARKERS SHALL BE ALIGNED SUCH THAT THE RETROREFLECTIVE SURFACES OF THE MARKER ARE ANGLED BETWEEN 85 TO 95 DEGREES TO THE DIRECTION OF ONCOMING TRAFFIC.
3. ADHESIVE FOR TEMPORARY PAVEMENT MARKERS SHALL BE EITHER HOT MELT ADHESIVE OR EPOXY ADHESIVE. REFER TO MRWA SPECIFICATION 604; SECTION 604.12.02 FOR FURTHER DETAILS.
4. FOR REFLECTIVITY OF TEMPORARY PAVEMENT MARKERS REFER TO MRWA SPECIFICATION 604; SECTION 604.12.01 FOR FURTHER DETAILS

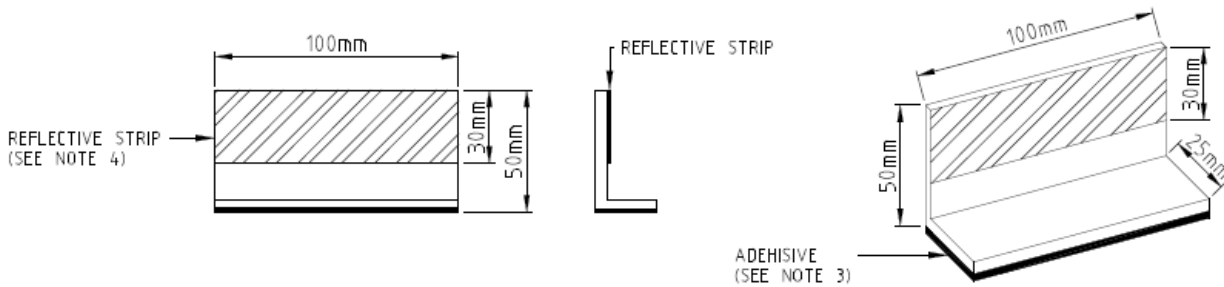
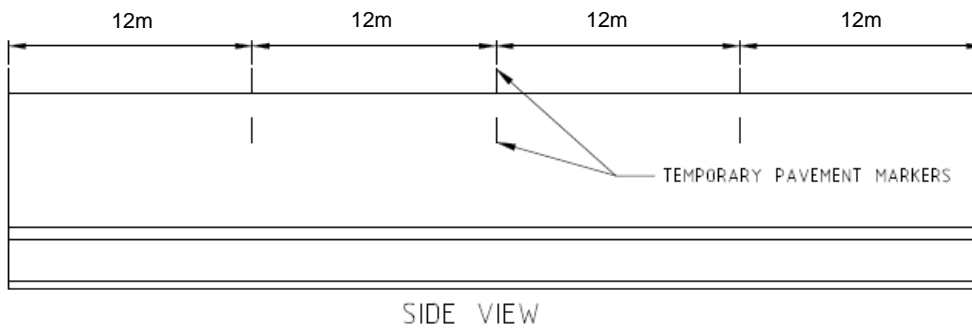
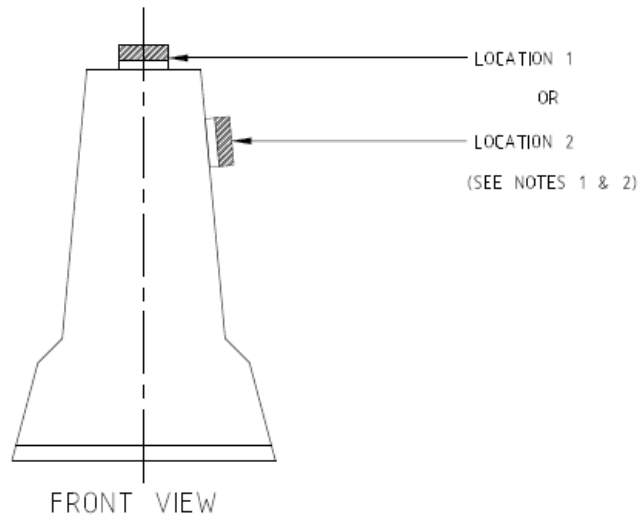

6.6.2 Barrier Edge Clearances

The below minimum edge clearances are recommended as a variation to table 5.1 of AGTTM Part 3.

Speed (km/h)	Distance (m)*
40 km/h or less	0.2
41-60 km/h	0.3
61-80 km/h	0.5
Greater than 80 km/h	1

Table 6 – Road Safety Barrier System Clearance to Traffic Lane

The above reduced clearance does not apply to the leading edge of the barrier system, Table 5.1 of AGTTM Part 3 should apply. This will reduce the risk of errant vehicles colliding with the end treatment of the barrier.

6.7 MINIMUM LANE WIDTHS

The below variation to the minimum lane widths in section 2.5.8 of AGTTM Part 3 and section 3.3.4 of AGTTM Part 2 may be applied (changes in red):

Criteria	Lane width (m)*
General lane widths	
≤ 60 km/h	3
61 – 80 km/h	3.2
> 80 km/h	3.5
Curve with radius 100 – 250 m	Curve widening 0.5 per lane
Curve with radius < 100 m	Consider swept path of long vehicles (e.g. buses, trams)
Approach lane is < 3 m wide	Equal to approach lane
Two-way residential street	5.5 (sum both ways)
Shuttle flow operation	
Shuttle flow with traffic control	3.2
Shuttle flow on residential streets	Maximum 3.5

*Note: *This does not apply to curves of radius 250 m or less, or locations where there are fixed vertical obstructions such as fences or safety barriers within 30 cm of the edge of the lane on one or both sides. Where these conditions apply, consider widths wider than those listed above to accommodate large vehicles.*

Table 7 – Minimum lane width

Refer to AGTTM for other considerations e.g. cyclists, heavy vehicles, etc.

6.8 TRAFFIC CONTROL

The following shall be read as a supplement to section 4.8 of AGTTM Part 3. WA has not adopted the method for estimating end of queue position or positioning of the PREPARE TO STOP, Traffic Controller (Symbolic), Signals Ahead or Boom Barrier signs.

As per section 5.10 in AGTTM Part 3, Traffic control refers to all methods of traffic control including by portable traffic control devices (e.g. portable traffic signals or boom barriers) or by manual traffic controllers.

No form of traffic control is permitted on any Freeway or grade separated highways with:

- a permanent speed limit of 90 km/h or more; and
- a traffic volume of 20,000 vpd or more.

6.8.1 Advanced Warning Signs

Where traffic may be required to stop due to traffic control, the PREPARE TO STOP sign shall be used in conjunction with the Traffic Controller (Symbolic), Signals Ahead or Boom Barrier sign (depending on the method of traffic control). Where possible the signs should be positioned side by side with the PREPARE TO STOP sign closest to the travel way.

The position of the PREPARE TO STOP sign and Traffic Controller (Symbolic), Signals Ahead or Boom Barrier sign shall be according to the local prevailing conditions, it is recommended they be placed a minimum distance as shown in table 8 in advance of the Traffic Control station.

Speed (km/h)	Distance (m)
50 or less	30
60	45
70 or more	Equal to the speed (km/h)

Table 8 – Traffic control warning sign spacing from control point

Note: Refer section 6.8.2 for avoiding end of queue collisions.

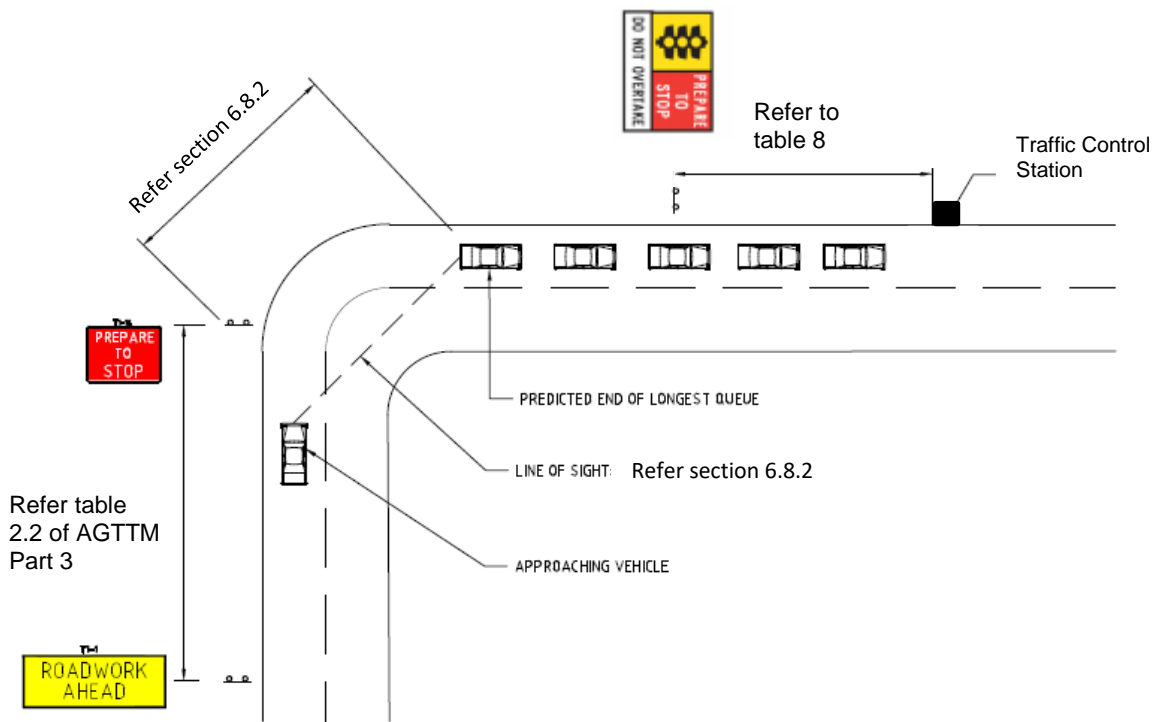

Notes:

1. Does not include all required signs and devices
2. Signs may need to be placed on both sides of the carriageway.

Figure 2: Placement of Traffic Controller Warning Signs (when using side by side)

The STOP HERE ON RED SIGNAL or STOP HERE WHEN DIRECTED sign shall be placed a minimum of 6 m in advance of the PTCD/traffic controller position. A temporary STOP line shall also be considered at this location using temporary removable road marking tape. There should be adequate distance between the PTCD/traffic controller position and the traffic control taper to ensure it can be safely negotiated by all vehicles, considering swept paths of large vehicles.

Section 4.8 of AGTTM Part 3, recommends four cones be placed on the centreline from the STOP HERE ON RED SIGNAL or STOP HERE WHEN DIRECTED sign position, which is encouraged, however where supported by a site specific risk assessment these cones may be omitted.

It is recognised that there is often limited space on some local roads due to things such as parked cars, footpaths, works occurring close to intersections, etc. The Worker (symbolic) and Traffic Controller (symbolic) signs may be used in the same MMS panel where all the following requirements are met:

- The road is a low speed local road (permanent speed 60 km/h or below);
- There are site constraints which do not allow the signs to be separated;
- The signs are used with the MMS-ADV-26 PREPARE TO STOP sign;
- The Traffic Controller (symbolic) sign (MMS-ADV-47) shall be positioned closest to the traffic;
- The signs shall be duplicated on both sides of the road or carriageway;
- The signs shall only be displayed when the need exists and removed or replaced when workers are not visible and/or there is no Traffic Controller requiring road users to stop.



6.8.2 Avoiding End of Queue Collisions

Queueing and delay are an expected consequence when any roadworks require the use of traffic control.

Before implementing any type of traffic control, it is the responsibility of the traffic management designer to consider the following:

- The speed of traffic
- The road environment (e.g. horizontal and vertical curves, road surface, road grade¹⁵)
- The sight distance road users will have to the traffic control position
- Driver reaction times (general case assumption = 2.5 sec)
- The traffic volume (including determining the peak traffic volumes within the proposed work period)
- The traffic composition (e.g. large vehicles will require greater stopping sight distance)
- Work times and duration
- Expected time traffic will be stopped
- Worksite length (see table 5.4 of AGTTM Part 3 for maximum length of single lane section)
- Personnel available

¹⁵ Downgrades may require greater stopping sight distance.

Once the traffic management designer has gained the above information the expected queue length can be predicted using the following steps:

1. Determine the hourly traffic volume in the direction of travel at the time of the works¹⁶;
2. Divide the hourly traffic volume by 60 to determine the vehicles expected every minute;
3. Determine the length of time to the nearest minute that vehicles will be required to stop (this includes stop time for work reasons and clearance times);
4. Multiply this number by the vehicles expected per minute (i.e. vehicles per minute X number of minutes);
5. Determine the types of vehicles that will be using the road and multiply its length by the number (include a 3 m space between each vehicle):

Vehicle Type	Approximate length
Car	5.5 m
Truck / Bus	19 m
Trucks (RAV 2-4)	27.5 m
Road Train / B Double	36.5 m
Triple Road Train / Large Combination	53.5 m

Table 9 – Approximate vehicle lengths

End of Queue Protection

The PREPARE TO STOP sign shall be placed a minimum distance as shown in table 10 in advance of the end of the queue when the speed is greater than 70 km/h¹⁷ or the sight distance of approaching traffic to the end of the queue is:

- less than two times the speed limit in open road areas
- less than 1.5 times the speed limit in built-up areas.

It is important to ensure adequate Stopping Sight Distance is provided to the PREPARE TO STOP sign and the end of queue. This is the distance required to allow a driver to react and stop their vehicle, this distance will generally be the distance shown in table 10 however if there are downgrades, large vehicles, poor surface condition, etc. the stopping distance will exceed these distances (for more details on Stopping Sight Distance see Austroads Guide to Road Design Part 3).

Speed (km/h)	Distance (m)
50 or less	30
60	90
70 or more	2 times the speed (km/h)

Table 10 – End of queue sign spacing

¹⁶ Traffic volumes can be provided by the relevant road authority. Where no traffic volumes are available the person preparing the plan should attend the site and count vehicles for a 5 minute period. Note that growth rates need to be considered when using data older than 12 months.

¹⁷ This shall be taken as the permanent posted speed limit.

The diagrams below depict how these signs should be laid out to ensure adequate advanced warning to road users.

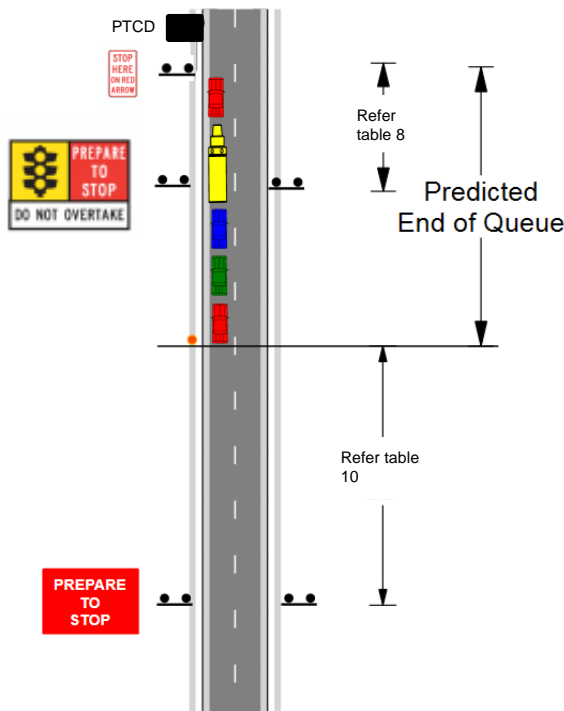

Figure 3: Avoiding end of queue collision

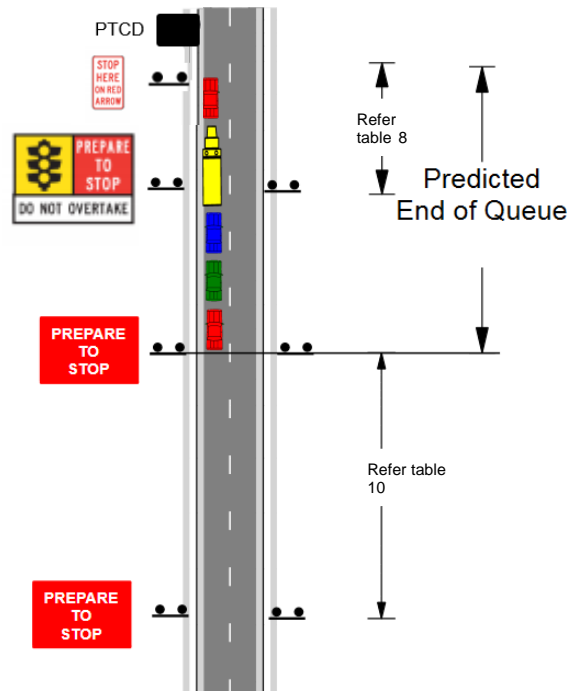

Figure 4: Avoiding end of queue collision (predicted queue length in table 11)

Diagram notes:

- The diagrams do not depict speed reduction and advanced warning signage which must be included (see table 2.2 of AGTTM Part 3 for sign spacing).
- The additional PREPARE TO STOP sign should be installed a distance provided in table 10 from the end of the queue.
- It is recommended the PREPARE TO STOP sign T1-18B or Queued Traffic ahead multi-message sign (MMS-ADV-90, MMS-ADV-91, MMS-ADV-26) is used in advance of the end of queue.
- Provide PREPARE TO STOP and symbolic warning sign in advance of the control point a distance shown in table 8.
- Sight distance to the end of queue should be a minimum distance provided in table 10 from the predicted end of queue for the peak period.
- Where the queue is expected to be more than the distance provided in table 11 additional PREPARE TO STOP sign at the predicted end of queue (figure 4).

Speed (km/h)	Distance (m) requiring additional Prepare to Stop at the end of queue location
50 or less	>60
60	>180
70 or more	>4 times the speed of traffic (km/h)

Table 11 – Predicted queue length requiring additional Prepare to Stop Sign

For further guidance see Traffic Control - Avoiding End of Queue Collisions on High Speed Roads Fact Sheet, go www.mainroads.wa.gov.au > 'Technical & Commercial' > 'Working on roads'.

6.8.3 Portable Traffic Control Devices

AGTTM states that portable traffic control devices (PTCD) are the preferred method to control traffic. However, it is accepted that it is not practical to use PTCDs for all work types and locations and higher risk locations need to be prioritised.

PTCDs must be used as the method of traffic control, for roads with:

- a permanent speed limit of 90 km/h or more and over 2,000 vpd; OR
- a permanent speed limit of 70 km/h or more and over 10,000 vpd*.

*except at permanent traffic signals.

Works on roads outside of the above should still consider the use of PTCDs and they may still be required based on a risk assessment. Traffic management planners should also refer to contractual requirements that may require the use of PTCDs regardless of the speed and/or traffic volume.

Main Roads is aiming to remove all manual traffic control (i.e. with Stop-Slow bats) on state controlled roads by mid-2022.

A risk assessment shall be conducted prior to considering the use of PTCD. This should examine duration of operation (set up time risk), what would happen in the event of failure assessing available sight distances, traffic volumes and traffic speeds. Mitigating factors shall include regular inspections and having back up traffic controllers. Wherever back up traffic controllers are provided they shall be positioned in a safe but prominent location to ensure drivers are aware that compliance with the PTCD is being observed.

PTCDs must be either:

- a portable traffic signal that complies with AS4191, or
- a PTCD that has been approved for use by Main Roads.

PTCD options include portable traffic signal systems (PTSS) and portable boom barriers. Both types of PTCDs have advantages and disadvantages. A combination of a boom barrier and traffic signal is likely to be the best method for controlling traffic, i.e. motorists are more accustomed to traffic signals, the traffic signal aspect is more visible, and the boom barrier provides a physical barrier to prevent motorists running the red light. It is expected, in the near future, the use of a boom barrier and traffic signal combination will be recommended under certain conditions when stopping traffic at temporary traffic management sites, e.g., traffic speed, traffic volume, duration of works, etc.

6.8.4 Traffic Controllers

Traffic Controllers are primarily used to manage, control and stop traffic where other signs and devices are considered insufficient. Accredited Traffic Controllers (see section 8) are required to operate in compliance with AGTTM Part 7: Traffic Controllers.

6.8.5 Stop-Slow Bats

When using a Stop-Slow bat to control traffic the B size, 600 mm diameter, STOP/SLOW face should be used unless the use of the A size, 450 mm diameter, STOP/SLOW face is supported by a risk assessment e.g. due to windy conditions.

6.9 TRUCK MOUNTED ATTENUATORS

A truck mounted attenuator (TMA) is a combination of Host Vehicle with a mounted Crash Attenuator to protect road workers.

The Requirements for the use of Truck Mounted Attenuators (TMAs) in WA – Code of Practice have now been adopted as a minimum requirement in WA. A copy is available on the Main Roads website at www.mainroads.wa.gov.au; go to 'Technical & Commercial' > 'Working on roads'.

Trailer Mounted Attenuators are not permitted in WA.

Refer to section 8.7 for TMA operator training requirements.

6.10 ILLUMINATED FLASHING ARROW SIGN

The primary illuminated flashing arrow signs should be used as follows:

Circumstance	Size
Lane closures or mobile works on roads with a permanent speed of 60 km/h or less	Size A 1260 x 650 mm
Lane closures or mobile works on roads with a permanent speed of 70 km/h or more	Size B 1500 x 770 mm
Lane closures or mobile works on: <ul style="list-style-type: none">• Any freeway; or• multilane roads with a speed of 90 km/h or more and 15,000 vpd or more; or• where a high level of long distance advance warning is desirable for safety	Size C 2400 x 1200 mm

Table 12 – Illuminated flashing arrow sign size

Note: the above does not apply to vehicle mounted warning devices on support / work vehicles.

The lamps used on the vehicle mounted warning device should meet the requirements of the Society for Automotive Engineers (SAE) Class 1 warning lights (i.e. be at least 8100 candela).

6.11 TRAFFIC VOLUME

AGTTM Part 2 Traffic Management Planning (table 3.1) and Part 3 Static Worksites (table 2.4) provide details on the number of traffic lanes to be provided, these requirements are accepted in WA (refer to section 4.5 of this code for variations).

6.12 MOBILE WORKS

Austrroads Guide to Temporary Traffic Management Part 4: Mobile Works is adopted in WA with the following departures:

AGTTM Section	Departure / Clarification
3.5.1 Lead Vehicle	<p>A lead vehicle is:</p> <ul style="list-style-type: none"> • Required when the line marking machine is painting the dividing line; or • Required when workers are on foot in a lane adjacent to oncoming traffic e.g. working in the lane on 2-way 2 lane undivided roads. <p>The lead vehicle may be omitted:</p> <ul style="list-style-type: none"> • On roads with a speed limit of 60 km/h or less, based on a risk assessment, e.g. if the convoy is determined to be too long for safe overtaking, or • When the work vehicle is in the lane adjacent to oncoming traffic with no workers on foot* <p>*A lead vehicle shall be considered, based on a risk assessment, if the work vehicle meets any one of the following:</p> <ul style="list-style-type: none"> - Does not have an enclosed cab; or - Is conditionally licenced; or - Has a mass less than 4 tonne.
3.5.3 Shadow Vehicle	<p>A shadow vehicle is required in all mobile work convoys in the live traffic lane – excludes shoulder grading (except where a risk assessment determines that the use of a shadow vehicle is required to adequately reduce the risk).</p> <p>For line marking activities on rural roads, the distance between the shadow vehicle and work vehicle may be increased to ensure adequate sight distance for approaching vehicles e.g., over a crest or around a bend. This must be based on a risk assessment and the shadow vehicle must always provide protection to the work vehicle.</p> <p>Truck Mounted Attenuators</p> <p>TMA's are only required at mobile works on:</p> <ul style="list-style-type: none"> • Roads with a speed limit of 80 km/h or more and 3,000 vpd or more; or • When conducting longitudinal road marking on state roads with a speed limit 80km/h or more; or • Any other road based on a risk assessment.
3.5.4 Advance Warning Vehicle	<p>As well as stopping for curved sections of road or where visibility is restricted, the advanced warning vehicle may remain stationary on the verge or shoulder at locations where there is limited shoulder or verge for the vehicle to continuously travel along e.g., due to culverts, roadside furniture, trees, steep batters, bridges, etc.</p> <p>The Advance Warning Vehicle does not have to be constantly moving with the convoy, as long as the general principle of it providing advanced warning to motorists is met.</p> <p>This must be based on risk assessment. The maximum spacing between the advanced warning vehicle and shadow vehicle must be included in the TMP and risk assessment.</p>

Table 13 – Mobile works AGTTM departures

6.13 SHADOW VEHICLE

For mobile works, AGTTM Part 4 requires a shadow vehicle to provide close protection to the rear of workers on foot. A shadow vehicle should also be considered at static worksites when workers on foot are in close proximity to traffic e.g. to protect workers within 3 m of live traffic.

At static worksites using a TMA, consideration should be given to using the TMA as a shadow vehicle to protect workers on foot or small plant items. When using the TMA as a shadow vehicle an additional illuminated arrow sign may be required at the commencement of the lane closure where the 'active' works is not in close proximity of the start of the lane closure, i.e. where sight distance and sight line requirements cannot be maintained an additional illuminated flashing arrow sign is required to assist road users in manoeuvring past the taper. Where the shadow vehicle is a TMA, the illuminated flashing arrow sign at the start of the lane closure is not required to be a TMA, this shall be based on a risk assessment.

The use and location of the shadow vehicle should be outlined in the TMP and TGS, the shadow vehicle should be within a reasonable proximity to workers.

Note: Main Roads is seeking to mandate the use of shadow vehicles on Main Roads roads in certain scenarios where workers on foot are not protected by a road safety barrier. Consultation will occur with relevant stakeholders prior to the next release of the Code of Practice.

7. BEST PRACTICE

Main Roads encourages the use of the following Traffic Management devices that increase the levels of safety, compliance and/or road user satisfaction at worksites.

7.1 INNOVATIVE TRAFFIC CONTROL DEVICES

When new innovative traffic control products emerge in the market there is a need for Main Roads to review and approve these devices before they are used to ensure they will be safe and effective. A list of recently approved devices and associated guidelines for use can be found on the Main Roads website, go to www.mainroads.wa.gov.au > 'Technical & Commercial > 'Working on roads'.

7.2 ELECTRONIC SPEED LIMIT SIGNS

The Road Traffic Code 2000 allows for the use of electronic speed limit signs.

The use of these on roadworks sites is encouraged, particularly in situations where: there are frequent changes in speed limits required as a part of the works OR it is hazardous to manually change speed limits OR the works are of a long term nature.

When using electronic speed limit signs; accurate time stamped records on exactly when the speed limits have been changed must be kept. The usual sign inspection regime must be adhered to and back up devices made available to enable prompt replacement of faulty electronic signs.

Refer to AS 5156: 2020 Electronic speed limit signs.



7.3 SPEED FEEDBACK SIGNS

Speed feedback signs (also referred to as speed radar signs, speed LED signs, Vehicle Activated Signs or speed radar VMS) detect vehicle speeds (using laser speed-detection equipment, for example) and either the speed or a message (e.g. SLOW DOWN) is displayed on an electronic sign. The primary purpose is to make drivers aware of their speed and encourage them to reduce their speed through the worksite. Research indicates that these are very effective in reducing drivers speed for short term purposes.

Speeds significantly above the posted speed limit must not be displayed on the sign, i.e. just a message, such as SLOW DOWN, should be shown.

Main Roads will look to mandate the use of these signs on Main Roads projects in the future, they should be considered at worksites on roads with 15,000 vpd or more that meet the following conditions:

- a temporary speed limit of more than 20 km/h below the posted speed (e.g. road with a permanent speed of 100 km/h reduced to 60 km/h); and
- workers are not protected by a road safety barrier¹⁸; and
- single lane of traffic in one direction past the work area

Where used in the above circumstances, the speed feedback signs should meet the following requirements:

- Have a display area greater than 430 mm x 430 mm
- Be positioned within or just in advance of the work area
- Be positioned away from traffic signals, so as not to cause motorist confusion
- The lower edge of the sign be a minimum of 1 m above the level of the nearest lane
- The display and optical requirements in accordance with AS 4852.2: 2019 Variable message signs Part 2: Portable signs.

7.4 TRAFFIC MONITORING AND SURVEILLANCE

The use of Body Cameras, Dash Cameras or other video surveillance is encouraged at temporary traffic management sites for the purposes of any of the following:

- Recording traffic incidents
- Recording traffic management inspections
- Site records
- Traffic monitoring
- As a deterrent or to record motorist non-compliance and/or aggressive behaviour.

Please note that anyone that conducts any form of video surveillance must ensure they are following all applicable surveillance and privacy laws. If you are in any doubt as to the legal requirements of the use of such devices, you should seek independent legal advice prior to their use.

The Monitoring Camera (MMS-ADV-83) sign should be used when using body cameras or other video surveillance as a deterrent or to record motorist non-compliance and/or aggressive behaviour.



MMS-ADV-83

¹⁸ Speed feedback signs may be used at locations where workers are protected by road safety barriers, however they should be prioritised at locations where workers are not protected.

8. ACCREDITATION REQUIREMENTS

8.1 GENERAL

Persons undertaking any of the tasks listed in Table 14 shall hold relevant Main Roads accreditation, as indicated:

Task	Required Main Roads Accreditation	Austrroads role title
On site manual traffic control using a Stop-Slow bat. Operate portable traffic signals systems. Operate portable boom barrier.	<i>Traffic Controller</i>	<i>Traffic Controller</i>
Selection of appropriate generic TGS, within an approved TMP, assess as site suitable and implement. Selection and Implementation of correct approved site specific TGS, required for the stage of works (or event). Monitor and maintain the performance of the implemented TGS. Adjustment of signs and devices within tolerances.	<i>Basic Worksite Traffic Management</i>	<i>Traffic Management Implementer (TMI)</i>
Implement traffic signs and devices from an approved TMP in accordance with AGTTM Part 5 – Short Term Low Impact Works e.g. Worker (symbolic), GRADER AHEAD, ROAD PLANT AHEAD or ROADWORK AHEAD.	<i>Basic Worksite Traffic Management – Non - Practitioner</i>	<i>Traffic Management Implementer – Non-Practitioner (TMI-NP)</i>
Review TMPs prepared by a person holding an AWTM accreditation. Monitoring the effectiveness of, and on-site adjustments to the Traffic Management Plan in accordance with its scope and objectives. This includes adjusting, adding and/or removing signs and devices where the intent/objectives of the TMP and operation of the road network are not adversely impacted. Changes to the TMP/TGS shall not involve adding lane or road closures, speed limit changes, or adding any additional regulatory signs that have not been approved (note: WTMs may add repeater signs).	<i>Worksite Traffic Management</i>	<i>Not currently in the Austrroads Training Framework, however the WTM accreditation will be retained in WA</i>
Prepare, review, monitor and adjust Traffic Management Plans and Traffic Guidance Scheme.	<i>Advanced Worksite Traffic Management</i>	<i>Traffic Management Designer (TMD)</i>
Review and endorsement of Traffic Management Plans involving 'complex traffic arrangements'. Suitability and compliance audits of Traffic Management Plans involving 'complex traffic arrangements', as may be specified for works undertaken for or on behalf of Main Roads. Undertaking 'risk management', and preparation or endorsement of, any Traffic Management Plan proposing to implement a lesser treatment than required by this Code for all works undertaken for or on behalf of Main Roads.	<i>Roadworks Traffic Manager</i>	<i>There is no equivalent in the Austrroads framework. RTMs to be retained in WA</i>
The operation of a truck mounted attenuator (TMA) when carrying out traffic management activities.	<i>Operate Truck Mounted Attenuator</i>	<i>TMA operator training is not included.</i>

Table 14 – Tasks Requiring Main Roads Accreditation

Any party intending to conduct works that may impact on traffic within any road reserve shall, as a condition of approval by Main Roads, local government or any other authority responsible for the road, ensure that the persons performing the tasks contained in Table 14 hold a relevant and current certificate of accreditation.

A Main Roads certificate is issued for each category of accreditation to individuals who successfully meet the pre-requisites applicable for each level of accreditation. Accreditation certificates are only permitted to be issued by Main Roads approved training providers. Contact details for Main Roads approved training providers are listed on the Main Roads website at www.mainroads.wa.gov.au; go to 'Technical & Commercial' > 'Working on roads' > 'Training and Accreditation'.

See section 1.3.2 for details on the Austroads Training Framework.

8.2 TRAFFIC CONTROLLER ACCREDITATION

A Main Roads Traffic Controller accreditation certificate will be issued to those meeting the following pre-requisites:

- an Australian Qualifications Framework compliant Statement of Attainment in the Resources and Infrastructure Industry Training Package Unit of Competency RIIWHS205D – Control traffic with a stop-slow bat, or equivalent (or the replacement unit of competency if and when applicable);
- an Australian Qualification Framework compliant Statement of Attainment in the Resources and Infrastructure Industry Training Package Unit of Competency RIICOM201D – Communicate in the workplace, or equivalent (or the replacement unit of competency if and when applicable);
- an Australian Qualification Framework compliant Statement of Attainment in the Resources and Infrastructure Industry Training Package Unit of Competency RIIWHS201D – Work safely and follow WHS policies and procedures, or equivalent (or the replacement unit of competency if and when applicable);
- current or previous evidence of holding a valid driver's licence¹⁹;
- evidence of been issued with a valid WorkSafe WA Construction Induction Training card.

Basic Worksite Traffic Management accreditation is also required where Traffic Controllers are responsible for installing and maintaining associated signing and devices, e.g. temporary speed limit signs, 'Prepare to Stop' signs, etc.

Where the above Statement of Attainment is obtained outside of Western Australia, applicants may be requested to undertake further training and assessment in the performance criteria specific to the laws, regulations and Codes of Practice that apply in Western Australia.

Accredited Traffic Controllers at roadwork sites in Western Australia shall operate in compliance with the AGTTM Part 7: Traffic Controllers.

¹⁹ The need to hold or have held a drivers' licence is to ensure an understanding of vehicle dynamics. Exemptions may be offered under certain circumstances.

8.3 BASIC WORKSITE TRAFFIC MANAGEMENT ACCREDITATION

A Main Roads accreditation certificate in Basic Worksite Traffic Management will be issued to those meeting the following pre-requisites:

- an Australian Qualifications Framework compliant Statement of Attainment in the Resources and Infrastructure Industry Training Package Unit of Competency RIIWHS302E – Implement traffic management plan, or equivalent (or the replacement unit of competency if and when applicable);
- an Australian Qualification Framework compliant Statement of Attainment in the Resources and Infrastructure Industry Training Package Unit of Competency RIICOM201D – Communicate in the workplace, or equivalent (or the replacement unit of competency if and when applicable);
- an Australian Qualification Framework compliant Statement of Attainment in the Resources and Infrastructure Industry Training Package Unit of Competency RIIWHS201D – Work safely and follow WHS policies and procedures, or equivalent (or the replacement unit of competency if and when applicable);
- evidence of been issued with a valid WorkSafe WA Construction Induction Training card.

Where the Statement of Attainment is obtained outside of Western Australia, applicants may be requested to undertake further training and assessment in the performance criteria specific to the laws, regulations and Codes of Practice that apply in Western Australia.

Where traffic devices are used, all work sites shall have at least one person with Basic Worksite Traffic Management accreditation on-site at all times when road workers are present.

Road workers with at least 12 months experience working on roads are permitted to implement signs under direct supervision of someone that holds a BWTM accreditation. This is only permitted on local roads with a permanent speed limit of 50 km/h or less and less than 15,000 vehicles per day.

8.3.1 Basic Worksite Traffic Management - Non - Practitioner

People that do not directly undertake TTM roles at worksites, such as parking inspectors, surveillance officers, grader operators, verge mowers, etc., but have previously gained BWTM accreditation may find it difficult to provide evidence of active industry engagement when applying for re-accreditation. In these cases rather than re-sitting the full BWTM course they may sit the refresher course and gain BWTM non-practitioner accreditation. This will allow them to implement signs and devices associated with short term low impact works, see AGTTM Part 5, that form part of a TMP.

8.4 WORKSITE TRAFFIC MANAGEMENT ACCREDITATION

A Main Roads accreditation certificate in Worksite Traffic Management will be issued to those meeting the following pre-requisites:

- an Australian Qualifications Framework compliant Statement of Attainment in the Resources and Infrastructure Industry Training Package Unit of Competency RIIRIS402D – Carry out the risk management process, or equivalent (or the replacement unit of competency if and when applicable), and;
- a current certificate of accreditation in Basic Worksite Traffic Management*, and;
- evidence of been issued with a valid WorkSafe WA Construction Induction Training card, and;
- attendance of the 4-day course in Advanced Worksite Traffic Management – including national units RIICWD503D - Prepare workzone traffic management plan and RIIRIS402D - Carry out the risk management process.

This includes successful completion of the in class written assessments which involves participants amending 3 TGSs that require updating. Participants to address site specific issues in the risk assessment and changes to be noted in the daily diary, and;

- documentary evidence of at least 1 year’s practical experience in traffic management;
or
- documentary evidence of at least 2 years practical experience in road construction or maintenance.

Expiry of pre-requisite Basic Worksite Traffic Management accreditation can be deferred to enable re-accreditation to coincide with the expiry of Worksite Traffic Management accreditation.

*Exemption from holding a current BWTM accreditation may be offered for employees working in Main Roads, local governments or other approving bodies with at least 3 years’ experience in traffic management, road safety, road construction/maintenance or road design that will be endorsing TMPs. Additionally, they must have previously held BWTM accreditation.

8.5 ADVANCED WORKSITE TRAFFIC MANAGEMENT ACCREDITATION

A Main Roads accreditation certificate in Advanced Worksite Traffic Management will be issued to those meeting the following pre-requisites:

- Documentary evidence of at least 1 years’ experience in traffic management, road asset management, road safety, road design, road construction or road maintenance;
- an Australian Qualifications Framework compliant Statement of Attainment in the Resources and Infrastructure Industry Training Package Unit of Competency RIICWD503E – Prepare work zone traffic management plan, or equivalent (or the replacement unit of competency if and when applicable);
- an Australian Qualifications Framework compliant Statement of Attainment in the Risk Management Unit of Competency RIIRIS402D – Carry out the risk management process, or equivalent (or the replacement unit of competency if and when applicable);
- evidence of holding or having held a Main Roads Western Australia accreditation in Basic Worksite Traffic Management or an Australian Qualification Frameworks compliant Statement of Attainment in ‘Implement Traffic Management Plan’.
- evidence of been issued with a valid WorkSafe WA Construction Induction Training card.

8.6 ROADWORKS TRAFFIC MANAGERS ACCREDITATION

Applications for Roadworks Traffic Manager accreditation are subject to assessment by the RTM Accreditation Panel comprising selected Government, professional and industry representatives. For further detail and application process go to the Main Roads website at www.mainroads.wa.gov.au; go to 'Technical & Commercial' > 'Working on Roads' > 'Training and Accreditation'.

Applicants are assessed based on the following minimum criteria:

- hold a current Main Roads' Advanced Worksite Traffic Management Accreditation;
- Have 5-years practical experience as an AWTM (or equivalent) responsible for the review, approval or design of Traffic Management Plans.
- Have completed the WA Road Safety Audit Course, within the previous 5 years, OR be a current practicing WA accredited Road Safety Auditor
- Have been an Audit Team Member or Audit Team Trainee on at least five Road Safety Audits or Temporary Traffic Management Audits within the previous two years under the guidance of an accredited Senior Road Safety Auditor or accredited Roadworks Traffic Manager
- Have been an Audit Team Member or Audit Team Trainee on at least one detailed design stage audit within the previous two years, under guidance of an accredited Senior Road Safety Auditor
- evidence of attending the Main Roads (or equivalent) Temporary Workzone Barrier design course, within the previous three years;
- Carried out at least one compliance or one suitability audit of a Traffic Management Plan involving 'complex traffic arrangements' under the guidance of an independent²⁰ Roadworks Traffic Manager.
- signing of Roadworks Traffic Managers Code of Conduct;
- have in place Professional Indemnity / Public Liability insurance certificate of currency*

*It is the responsibility of RTMs, as well as anyone engaging them, to ensure they have the appropriate level of insurance.

Applicants that the Panel assesses to have met these prerequisites will be required to undertake an 'in office' assessment to verify their traffic management knowledge.

²⁰ Independent is defined as not having the potential for financial gains.

8.7 OPERATE TRUCK MOUNTED ATTENUATOR

A Main Roads accreditation certificate in Operate Truck Mounted Attenuator will be issued to those meeting the following pre-requisites:

- an Australian Qualification Framework compliant Statement of Attainment in the Resources and Infrastructure Industry Training Package Unit of Competency RIICOM201D – Communicate in the workplace, or equivalent (or the replacement unit of competency if and when applicable);
- an Australian Qualification Framework compliant Statement of Attainment in the Resources and Infrastructure Industry Training Package Unit of Competency RIIRTM301D – Operate a truck or trailer mounted attenuator, or equivalent (or the replacement unit of competency if and when applicable);
- hold a current and valid heavy vehicle licence of a suitable class to operate the TMA (Medium Rigid licence as a minimum)
- documentary evidence of at least 80 hours experience operating heavy vehicles in the last 6 months;
- hold a valid Work Safe WA Construction Induction Training card;
- hold a current Main Roads Basic Worksite Traffic Management Accreditation (see 8.3);
- documentary evidence of at least 50 hours practical experience in traffic management in the last 6 months.

8.8 PROOF OF CERTIFICATION

Proof of certification is issued by training providers in the form of a 'Photo ID' card. Persons performing on-site traffic management tasks shall always carry this proof of certification with them.

A database of persons holding current accreditation is maintained by training providers on Main Roads website at www.mainroads.wa.gov.au; go to 'Technical & Commercial' > 'Working on Roads' > 'Training and Accreditation'.

8.9 ISSUE OF CERTIFICATION AND RE-ACCREDITATION

The issue of accreditation can only be undertaken by training providers that have the relevant training Unit of Competency in their scope of registration by the WA Training Accreditation Council or Australian Skills Quality Authority, and are separately approved by Main Roads to issue such accreditation. For those seeking accreditation based on Statements of Attainment issued outside of Western Australia, applicants must be able to demonstrate knowledge of relevant laws, regulations, and codes of practice specific to Western Australia.

All Main Roads accreditations are valid for three years, following which re-accreditation is required. Re-accreditation is subject to persons being 'refreshed' on any changes to relevant laws, regulations, standards, and codes of practice that may have occurred since the issue of the previous accreditation. Applicants must have achieved statements of attainment in the current units of competency (or equivalent) prior to being re-accredited (previous unit versions are acceptable e.g., RIIOHS302A and RIIOHS205A).

9. FURTHER INFORMATION

Further information relating to this Code may be obtained from:

Gareth Peers
Main Roads Western Australia
PO Box 6202
EAST PERTH WA 6892

Phone: 138 138
Email: enquiries@mainroads.wa.gov.au

10. REFERENCES

- AS 1742 – Manual of uniform traffic control devices
 - Part 1 – General introduction and index of signs 2014
 - Part 2 – Traffic control for general use 2009
 - Part 3 – Traffic control for works on roads 2019
 - Part 4 – Speed controls 2008
- AS 1743:2018 – Road signs – Specifications
- AS 4852.2: 2019 Variable message signs Part 2: Portable signs.
- AS 5156: 2020 Electronic speed limit signs.
- AS/NZS 1906 – Retroreflective materials and devices for road traffic control purposes
 - Part 1 – Retroreflective sheeting 2017
 - Part 2 – Retroreflective devices (non-pavement application) 2007
 - Part 3 – Raised pavement markers (retroreflective and non-retroreflective) 2017
 - Part 4 – High visibility materials for safety garments 2010
- AS/NZS 3845.1:2015 – Road safety barrier systems and devices – Road safety barrier systems
- AS/NZS 3845.2:2017 Road safety systems and devices – Road safety devices
- AS/NZS ISO 31000:2018 – Risk Management – Guidelines
- AS/NZS 4602.1:2011 – High visibility safety garments – Garments for high risk applications
- Austroads Glossary of Terms
- Austroads Guide to Road Design
- Austroads Guide to Traffic Management
- Austroads Guide to Temporary Traffic Management
- Disability Services Act 1993
- Local Government Act 1995
- Main Roads Act 1930
- Main Roads Specification 601 – Signs
- Main Roads Specification 604 – Pavement Marking
- Occupational Safety & Health Act 1984
- Occupational Safety & Health Regulations 1996
- Requirements for the Use of Truck Mounted Attenuators in WA – Code of Practice
- Road Traffic Act 1974
- Road Traffic Code 2000

- Temporary Traffic Management: Traffic Signals Approval Policy
- Traffic Management at Roadworks on State Roads Policy and Application Guidelines
- Traffic Management for Events Code of Practice
- Utility Providers Code of Practice for Western Australia

APPENDIX 1 – Definitions

The following definitions are specific to this Code, refer to AGTTM Part 1 for all definitions relating to temporary traffic management.

Access roads:	As per Metropolitan Functional Road Hierarchy definitions below ⁽¹⁾
Authorised Body:	Being the same definition as that in Regulation 3 of the Road Traffic Code 2000 – means a government department, government instrumentality, statutory authority, local government or a body authorised by the Commissioner of Main Roads for the purposes of Regulation 297(2) of the Road Traffic Code 2000
Carriageway:	Section of the road devoted particularly to the use of vehicles, that is between the guideposts, kerbs or barriers where these are provided, inclusive of shoulders and auxiliary lanes
Children’s Crossing:	Means a warranted children’s crossing controlled by a Traffic Warden employed by the WA Police Force.
Direct Supervision:	Within visual and verbal communication of a qualified person
District distributor:	As per Metropolitan Functional Road Hierarchy definitions below ⁽¹⁾
Duty of care:	The legal duty on the part of all employers, employees and others including contractors and consultants who have an influence on the potential hazards in a work site, which requires them to take reasonable care to protect the health and safety of others at the work site including road users who may be at a foreseeable risk of harm
Emergency:	A situation where a life threatening risk exists and the consequences of not taking action are judged to be worse than if action is taken.
Instrument of Authorisation:	A legal instrument through which the Commissioner of Main Roads, under Regulation 297 of the Road Traffic Code 2000, formally delegates to an Authorised Body the authority to erect, establish or display and alter or take down any road sign or traffic control signal for the purpose and duration of any roadworks subject to conditions set out in the instrument. In order to take effect, the instrument must be executed by the Commissioner and the body the subject of the instrument.
Level of Service:	(a) An index of the operational performance of traffic on a given traffic lane, carriageway or road when accommodating various traffic volumes under different combinations of operating conditions
Metropolitan Area / Region	Main Roads regional boundaries can be found using the Road Information Mapping (RIM) system, go to www.mainroads.wa.gov.au > ‘Technical & Commercial’ > ‘Open Data, Maps & Apps’ > ‘Road Information Mapping’

Must	Indicates that a statement is mandatory (must and shall may be used interchangeably)
Primary distributor:	As per Metropolitan Functional Road Hierarchy definitions below ⁽¹⁾
Rail Infrastructure Manager	An organisation responsible for managing the safe operation of a railway. This is often separate to the rail owner.
Residential Road / Street	Normally a single carriageway, two-way road in a residential district of an urban area carrying little through traffic and few large vehicles even during peak hours. Such roads have a speed limit not exceeding 60 km/h.
Residual risk:	Risk remaining after risk treatment (process to modify risk). Residual risk can contain unidentified risk. Residual risk can also be known as 'retained risk'.
Road:	For the purpose of this Code has the same meaning as that defined in Main Roads Act: means any thoroughfare, highway or road that the public is entitled to use and any part thereof, and all bridges (including any bridge over or under which a road passes), viaducts, tunnels, culverts, grids, approaches and other things appurtenant thereto or used in connection with the road;
Road reserve:	For the purpose of this Code includes the land set aside, gazetted under an enactment or commonly used by the public as a road and all verges, traffic islands, median strips and other provisions associated therein for the conveyance or travel persons but does not include private tenements or freehold land.
School Zone:	Means a carriageway or length of carriageway (a) defined at its beginning by means of a 'School Zone' sign and at its end by means of an 'End School Zone' sign; or (b) that forms part of a network of 2 or more carriageways defined by means of 'school zone' signs erected near the boundary of each carriageway that provide access to the network and 'End School Zone' signs erected near the boundary of each carriageway that provided exit from the area.
School Zone Period:	Means the days (if any), and the period (if any) during those days, that the speed limit indicates by a 'School Zone' sign has effect.
Shall:	Indicates that a statement is mandatory (must and shall may be used interchangeably)
Should:	Indicates a recommendation.
Speed zone:	A length of road subject to legally enforceable speed limits

Traffic Control Diagram (TCD): See Traffic Guidance Scheme

Traffic Management Plan (TMP): A document containing Traffic Guidance Schemes and documentation of project details in regard to traffic management at a work site. The documentation of project details includes, inter alia, responsible personnel, proposed timing of the works, approvals that have been gained, traffic volume/type details, documentation of risk management and special provisions for specific road user types.

Traffic Warden: Means a person appointed as a warden under regulation 23 Road Traffic (Administration) Act 2008 to control vehicles and pedestrians at children's crossings and pedestrian crossings

NOTES:

⁽¹⁾Metropolitan Functional Road Hierarchy Definitions

Primary Distributors: These provide for major regional and inter-regional traffic movement and carry large volumes of generally fast moving traffic. Some are strategic freight routes and all are National or State roads. They are managed by Main Roads.

District Distributor A: These carry traffic between industrial, commercial and residential areas and generally connect to Primary Distributors. These are likely to be truck routes and provide only limited access to adjoining property. They are managed by local government.

District Distributor B: Perform a similar function to type A District Distributors but with reduced capacity due to flow restrictions caused by access to and roadside parking alongside adjoining property. These are often older roads with a traffic demand in excess of that originally intended. District Distributor A and B roads run between land-use cells and generally not through them, forming a grid which would ideally space them around 1.5km apart. They are managed by local government.

Local Distributors: Carry traffic within a cell and link District Distributors at the boundary to access roads. The route of the Local Distributor discourages through traffic so that the cell formed by the grid of District Distributors only carries traffic belonging to or serving the area. These roads should accommodate buses but discourage trucks. They are managed by local government.

Access Roads: Provides access to abutting properties with amenity, safety and aesthetic aspects having priority over the vehicle movement function. These roads are bicycle and pedestrian friendly. They are managed by local government.

The decision about which functional type should be designated to each road can only be made by the Authority responsible for managing that road.

APPENDIX 2 – Traffic Risk Classification

In order to clearly understand the risks associated with the works and then outline the manner in which identified risks will be managed, the TMP designer needs to undertake an assessment of all significant foreseeable risks associated with the works and determine the treatment measures that, so far as practicable, minimise the risk.

The identification and assessment process is to be undertaken in accordance with AS/NZS ISO 31000 and the likelihood and consequences rated before the application of risk treatments (primary risk) and after (residual risk) the determined controls utilising Table A2-1, Table A2-2, Table A2-3, and Table A2-4 below.

The TMP designer is to, so far as practicable, control or reduce identified risks in accordance with the hierarchy of control. Treatment measures are to be in accordance with the below Table A2-5 Management Approach for Residual Risk Rating.

A Residual Risk Rating of Very High is not permissible.

TABLE A2-1 – QUALITATIVE MEASURES OF CONSEQUENCE OR IMPACT

Consequence	Description
Insignificant	Midblock hourly traffic flow per lane is equal to or less than the allowable lane capacity detailed in AGTTM. No impact to the performance of the network. Affected intersection leg operates at a Level of Service (LoS) of A or B. No property damage.
Minor	Midblock hourly traffic flow per lane is greater than the allowable road capacity and less than 110% of the allowable road capacity as detailed in AGTTM. Minor impact to the performance of the network. Intersection performance operates at a Level of Service (LoS) of C. Minor property damage.
Moderate	Midblock hourly traffic flow per lane is equal to and greater than 110% and less than 135% of allowable road capacity as detailed in AGTTM. Moderate impact to the performance of the network. Intersection performance operates at a Level of Service (LoS) of D. Moderate property damage.
Major	Midblock hourly traffic flow per lane is equal to and greater than 135% and less than 170% of allowable road capacity as detailed in AGTTM. Major impact to the performance of the network. Intersection performance operates at a Level of Service (LoS) of E. Major property damage.
Catastrophic	Midblock hourly traffic flow per lane is equal to and greater than 170% of allowable road capacity as detailed in AGTTM. Unacceptable impact to the performance of the network. Intersection performance operates at a Level of Service (LoS) of F. Total property damage.

TABLE A2-2 OSH QUALITATIVE MEASURES OF CONSEQUENCE OR IMPACT

Level	Consequence	Description
1	Insignificant	No treatment required
2	Minor	First aid treatment required.
3	Moderate	Medical treatment required or Lost Time Injury
4	Major	Single fatality or major injuries or severe permanent disablement
5	Catastrophic	Multiple fatalities.

TABLE A2-3 – QUALITATIVE MEASURES OF LIKELIHOOD

Likelihood	Description
Rare	The event or hazard: may occur only in exceptional circumstances, will probably occur with a frequency of less than 0.02 times per year (i.e. less than once in 50 years).
Unlikely	The event or hazard: could occur at some time, will probably occur with a frequency of 0.02 to 0.1 times per year (i.e. once in 10 to 50 years).
Possible	The event or hazard: might occur at some time, will probably occur with a frequency of 0.1 to 1 times per year (i.e. once in 1 to 10 years).
Likely	The event or hazard: will probably occur in most circumstances, will probably occur with a frequency of between 1 and 10 times per year.
Almost certain	The event or hazard: is expected to occur in most circumstances, will probably occur with a frequency in excess of 10 times per year.

IMPORTANT NOTE: The likelihood of an event or hazard occurring shall first be assessed over the duration of the activity (i.e. “period of exposure”). For risk assessment purposes the assessed likelihood shall then be proportioned for a “period of exposure” of one year.

Example: An activity has a duration of 6 weeks (i.e. “period of exposure” = 6 weeks). The event or hazard being considered is assessed as likely to occur once every 20 times the activity occurs (i.e. likelihood or frequency = 1 event/20 times activity occurs = 0.05 times per activity). Assessed annual likelihood or frequency = 0.05 times per activity x 52 weeks/6 weeks = 0.4 times per year. Assessed likelihood = Possible.

TABLE A2-4 – QUALITATIVE RISK ANALYSIS MATRIX – RISK RATING

Likelihood	Consequence				
	Insignificant (1)	Minor (2)	Moderate (3)	Major (4)	Catastrophic (5)
Almost certain (A)	Low 5	High 10	High 15	Very High 20	Very High 25
Likely (B)	Low 4	Medium 8	High 12	Very High 16	Very High 20
Possible (C)	Low 3	Low 6	Medium 9	High 12	High 15
Unlikely (D)	Low 2	Low 4	Low 6	Medium 8	High 10
Rare (E)	Low 1	Low 2	Low 3	Low 4	Medium 7

TABLE A2-5 – MANAGEMENT APPROACH FOR RESIDUAL RISK RATING

Residual Risk Rating	Required Treatment
Very High	Unacceptable risk. HOLD POINT . Work cannot proceed until risk has been reduced.
High	High priority, Roadworks Traffic Manager (RTM) must review the risk assessment and approve the treatment and endorse the TGS prior to its implementation.
Medium	Medium Risk, standard traffic control and work practices subject to review by accredited AWTM personnel prior to implementation.
Low	Managed in accordance with the approved management procedures and traffic control practices.

APPENDIX 3 – Typical Instrument of Authorisation for Local Government

**WESTERN AUSTRALIA
ROAD TRAFFIC CODE 2000
REGULATION 297(2)
INSTRUMENT OF AUTHORISATION**

Pursuant to Regulation 297(2) of the Road Traffic Code 2000 the Commissioner of Main Roads ('the Commissioner') hereby authorises *(Insert name of Local Government)* ('Authorised Body') by itself, its employees, consultants, agents and contractors (together 'Representatives') to, from the date indicated below, erect, establish, display, alter or take down such traffic signs and traffic control devices of whatsoever type or class (except for permanent traffic control signals) as may be required for the purpose and duration of any works, survey or inspection, associated with the construction, maintenance or repair on a road (other than a main road or highway), any adjoining land or any portion thereof within its jurisdiction, SUBJECT ALWAYS to the following terms and conditions:

- (a) the Authorised Body shall at all times observe, perform and comply with the provisions of the 'Traffic Management for Works on Roads Code of Practice' (as amended or replaced from time to time in consultation with the Traffic Management for Roadworks Advisory Group) issued by Main Roads Western Australia ('the Code') referring to the version which is current at the time of the relevant works, a copy of which can be obtained from Main Roads Western Australia from www.mainroads.wa.gov.au or by contacting Main Roads by phone;
- (b) the Authorised Body shall develop and implement procedures that will satisfy the Commissioner that traffic management implemented by the Authorised Body, its employees, agents and contractors will in all respects conform to and comply with the requirements of the Code; and
- (c) the Authorised Body shall ensure that its Representatives comply with the terms and conditions identified above at paragraphs (a) and (b) as if they were named in those paragraphs in place of the Authorised Body.

By executing and returning the acknowledgment at the foot of this authorisation, the Authorised Body agrees to observe, perform and comply with the above terms and conditions.

This Instrument of Authorisation replaces any prior Instrument of Authorisation under Regulation 297(2) of the Road Traffic Code 2000 between the Commissioner and the Authorised Body. The Commissioner's delegation dated 17 July 1975 to a number of local governments outside the Perth metropolitan area, is not affected by this Instrument of Authorisation except that this Instrument of Authorisation prevails wherever roadworks are concerned. That 1975 delegation was made under Regulation 301 of the Road Traffic Code 1975 and related to non-regulatory signage.

Dated:

THE COMMON SEAL OF THE)
COMMISSIONER OF MAIN ROADS)
WAS AFFIXED BY)
)
)
COMMISSIONER OF MAIN ROADS)
FOR THE TIME BEING IN THE PRESENCE OF:)

Signature of Witness

Name of Witness

ACKNOWLEDGMENT BY AUTHORISED BODY

(Insert name of Local Government) agrees to observe, perform and be bound by the above conditions.

THE COMMON SEAL OF THE)

(Insert name of Local Government))
WAS AFFIXED PURSUANT TO A RESOLUTION)
OF THE COUNCIL IN THE PRESENCE OF)

Chief Executive Officer

Witness

APPENDIX 4 – Sample ‘Notification of Roadworks’ Form

A sample Notification of Roadworks form is provided on page x. **NOTE:** The distribution list in this form is based on Perth metropolitan area and it needs to be appropriately modified for use elsewhere.

An electronic version of the sample Notification of Roadworks form is available on Main Roads website www.mainroads.wa.gov.au; go to ‘Technical & Commercial’ > ‘Working on Roads’ > ‘Traffic Management Templates’.

Contact details of Main Roads Regional Offices for sending the Notification of Roadworks forms and TMPs are given in Table A4-1 below.

Region	Email	Phone
Kimberley (Derby and Kununurra)	Kimreg@mainroads.wa.gov.au	(08) 9158 4333 (Derby) (08) 9167 4777 (Kununurra)
Pilbara (South Hedland)	NoR Form: Pilreg@mainroads.wa.gov.au TMP submissions: Pilbaranetworkmanagement@mainroads.wa.gov.au	(08) 9172 8877
Mid West - Gascoyne (Geraldton and Carnarvon)	MWGreg@mainroads.wa.gov.au	(08) 9941 0777 (Carnarvon) (08) 9956 1200 (Geraldton)
Goldfields – Esperance (Kalgoorlie)	GEreg@mainroads.wa.gov.au	(08) 9080 1400
Wheatbelt (Northam and Narrogin)	Wheatbelt@mainroads.wa.gov.au	(08) 9622 4777 (Northam) (08) 9881 0566 Narrogin
Great Southern (Albany)	GSreg@mainroads.wa.gov.au	(08) 9892 0555
South West (Bunbury)	SWreg@mainroads.wa.gov.au	(08) 9724 5656

Table A4-1 – Main Roads Regional contact details for sending Notification of Roadworks forms and TMPs

NOTIFICATION OF ROADWORKS

Notifications are to be distributed at least one (1) week in advance of works
Where the traffic management is to interfere with traffic signal operation, prior approval is required 3wks in advance via enquiries@mainroads.wa.gov.au.

Where the works will place restrictions on Oversize and/or Restricted Access Vehicles Main Roads HVS requires at least 2 weeks' notice.

TMP reference		Communication plan sent to Main Roads	Yes <input type="checkbox"/>	No <input type="checkbox"/>	N/A <input type="checkbox"/>		
			If No provide reason. If Yes provide email contact				
Anticipated start date:		Anticipated finish date:					
Daily work hours:		Is weekend work applicable?	Yes <input type="checkbox"/>	No <input type="checkbox"/>			
Location of works (Road/Street, Suburb):							
Description of works:							
Description of traffic management arrangements:							
Posted Speed Limit:		Worksite speed limit:		After hours speed limit:			
What is the anticipated effect on traffic flows?			Will there be restricted width for oversize escorted vehicles?	Yes <input type="checkbox"/>	No <input type="checkbox"/>		
Are lanes closed at signals?	Yes <input type="checkbox"/>	No <input type="checkbox"/>	N/A <input type="checkbox"/>	Are signal loops or hardware affected?	Yes <input type="checkbox"/>	No <input type="checkbox"/>	N/A <input type="checkbox"/>
Will signal phases need time changes?	Yes <input type="checkbox"/>	No <input type="checkbox"/>	N/A <input type="checkbox"/>	Will signals need to revert automatically?	Yes <input type="checkbox"/>	No <input type="checkbox"/>	N/A <input type="checkbox"/>
Date of signal 'black out':			Times of signal 'black out':				
Will Police attendance be required?	Yes <input type="checkbox"/>	No <input type="checkbox"/>		Dates for Police attendance:			
Are bridges located in area of works, (inc detours)?	Yes <input type="checkbox"/>	No <input type="checkbox"/>		Will changes to traffic flows/composition occur on bridges?	Yes <input type="checkbox"/>	No <input type="checkbox"/>	
Are the works located within a School Zone?	Yes <input type="checkbox"/>	No <input type="checkbox"/>		Will children's crossings be altered during works?	Yes <input type="checkbox"/>	No <input type="checkbox"/>	

Oversize and/or Restricted Access Vehicle Roadwork Restrictions

Location of works (include – road name, nearest intersection or marked location and SLKs)							
Road Name(s)							
Bridge number if applicable							
Nearest Intersection / marked location / SLKs							
Additional information							
Will there be a width restriction for oversize vehicles exceeding 2.5m in width?	Yes <input type="checkbox"/>	No <input type="checkbox"/>	Will there be a height restriction for oversize vehicles exceeding 4.3m in height?		Yes <input type="checkbox"/>	No <input type="checkbox"/>	
If yes, what width limit is to be imposed on oversize vehicles travelling through the site?							
Will the width restrictions be in place outside the daily work hours?	Yes <input type="checkbox"/>	No <input type="checkbox"/>	If yes, what is the minimum height of the structure causing the restriction?				
Can the width restrictions be removed if operators provide prior notice?	Yes <input type="checkbox"/>	No <input type="checkbox"/>	If the width restrictions are fixed in place, are operators able to have a wider oversize combination if a 1.2m ground clearance can be achieved? Do not complete if width restrictions can be removed.		Yes <input type="checkbox"/>	No <input type="checkbox"/>	
If yes, how much notice will be required? (i.e. 24/48 hours' notice).			If yes, how much notice will be required? (i.e. 24/48 hours' notice).				
Please provide the name and phone number of the best contact for further details in relation to these works.	Name:						
	Contact number (mobile):						
Please provide the name and phone number of the contact for prior notification of movements.	Name:						
	Contact number (mobile):						

Will the work result in a road closure that will impact on Restricted Access Vehicles?	Yes <input type="checkbox"/>	No <input type="checkbox"/>	If yes, have discussions been held with Main Roads Heavy Vehicle Services (HVS) in regards to a suitably approved RAV network detour. If no, please contact HVS Route Assessments on 138 486 for assistance. Note: an assessment request for a proposed detour may take up to a week to be processed.	Yes <input type="checkbox"/>	No <input type="checkbox"/>

Road Authority:					
Postal Address:					
Telephone:		Email:		Facsimile:	
Contact:					
Telephone:		Email:		Mobile:	

Construction Contractor:					
Postal Address:					
Telephone:		Email:		Facsimile:	
Contact:					
Telephone:		Email:		Mobile:	
After hours contact:		Telephone:		Mobile:	

Traffic Management Contractor:					
Postal Address:					
Telephone:		Email:		Facsimile:	
Contact:					
Telephone:		Email:		Mobile:	
After hours contact:		Telephone:		Mobile:	

Distribution List	Email/Website
Main Roads Digital Communications	communications@mainroads.wa.gov.au
Main Roads Real Time Media	roadworks@mainroads.wa.gov.au
Main Roads Customer Information Centre	enquiries@mainroads.wa.gov.au
Main Roads Road Network Operations Centre	RNOC.Control.Room.Information.Desk@mainroads.wa.gov.au
Main Roads Heavy Vehicle Services	hvsnor@mainroads.wa.gov.au
Main Roads Engineer Bridge Loading	DLSEHeavyLoadsGroup@mainroads.wa.gov.au
WA Police State Traffic Coordination	State.Traffic.Intelligence.Planning.&.Co-ordination.Unit.SMMAIL@police.wa.gov.au
Children's Crossing Unit	childrencrossingunitsmail@police.wa.gov.au
St John Ambulance	operations_soc@stjohnwa.com.au
Fire & Emergency Services	For relevant contact details see website: www.dfes.wa.gov.au/contactus/pages/dfesoffices.aspx
Public Transport Authority	For relevant contact details see website: www.pta.wa.gov.au/AboutUs/ContactUs
Arc Infrastructure	thirdparty_notifications@arcinfra.com
Local Government	For contact details see local government website

Note: the above distribution list is an example and should be modified as required. See section 4.4











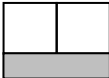

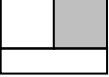

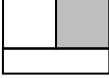
APPENDIX 5

Multi-Messages Sign Inventory



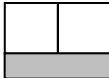

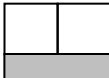





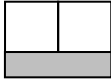
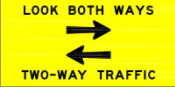



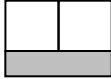

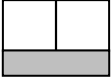
And

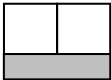

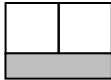



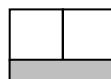



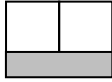

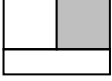

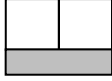

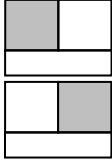

Application Schedule

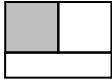

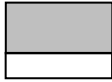



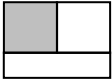

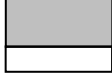





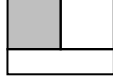



APPENDIX 5 - Multi-Message Sign Inventory and Application Schedule



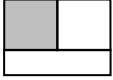



Group	ADVANCE WARNING SERIES SIGNS			SIGN APPLICATION AND DESCRIPTION	
	Sign	Main Roads Sign Number	Panel Size (mm)		
A D V		MMS-ADV-1	1200 x 300		<p>'X' km AHEAD</p> <ul style="list-style-type: none"> • Shall not be used in conjunction with a regulatory speed sign.
A D V		MMS-ADV-2	600 x 600		<p>'X' km AHEAD</p> <ul style="list-style-type: none"> • Shall not be used in conjunction with a regulatory speed sign. • Sign may be classified as symbolic.
A D V		MMS-ADV-3	600 x 600		<p>40 km/h AHEAD SYMBOLIC</p>
A D V		MMS-ADV-3	600 x 600		<p>60 km/h AHEAD SYMBOLIC</p>
A D V		MMS-ADV-3	600 x 600		<p>80 km/h AHEAD SYMBOLIC</p>
A D V		MMS-ADV-4	1200 x 300		<p>AT INTERSECTION</p> <ul style="list-style-type: none"> • Shall not be used in conjunction with a regulatory sign.
A D V		MMS-ADV-5	1200 x 300		<p>AT SIGNALS</p> <ul style="list-style-type: none"> • Shall not be used in conjunction with a regulatory sign.
A D V		MMS-ADV-6	1200 x 600		<p>BLASTING AREA SWITCH OFF RADIO TRANSMISSION</p> <ul style="list-style-type: none"> • Only to be used where the posted speed is less than or equal to 80km/h.

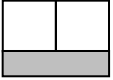



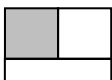

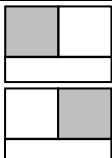



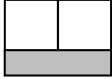

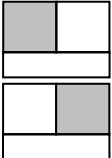



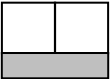

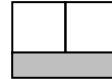
A D V		MMS-ADV-7	600 x 600		BRIDGEWORK AHEAD
A D V		MMS-ADV-8	1200 x 600		BRIDGEWORK AHEAD
A D V		MMS-ADV-9A	600 x 600		DETOUR AHEAD
A D V		MMS-ADV-9B	1200 x 600		DETOUR AHEAD
A D V		MMS-ADV-10	1200 x 300		DO NOT OVERTAKE
A D V		MMS-ADV-11	1200 x 300		DRIVE SLOWLY
A D V		MMS-ADV-12	600 x 600		GRADER AHEAD
A D V		MMS-ADV-13	600 x 600		HEAVY VEHICLES
A D V		MMS-ADV-14	600 x 600		HIGH VEHICLES
A D V		MMS-ADV-15	600 x 600		LINE MARKING

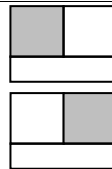







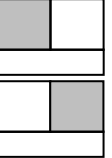

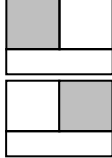



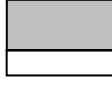

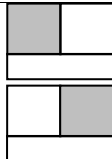

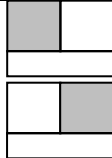

A D V		MMS-ADV-16	1200 x 300		LINE MARKING
A D V		MMS-ADV-17	1200 x 600		LOOK BOTH WAYS TWO WAY TRAFFIC
A D V		MMS-ADV-18	600 x 600		NEXT 'X' km <ul style="list-style-type: none"> • Shall not be used in conjunction with a regulatory speed sign. • Sign may be classified as symbolic.
A D V		MMS-ADV-19	1200 x 300		NEXT 'X' km (WHITE) <ul style="list-style-type: none"> • Shall not be used in conjunction with a regulatory speed sign.
A D V		MMS-ADV-20	1200 x 300		NOW <ul style="list-style-type: none"> • Shall only be used in conjunction with the sign MMS-ADV-30.
A D V		MMS-ADV-21	1200 x 300		OBSTRUCTION MARKER <ul style="list-style-type: none"> • Shall not be used in conjunction with an Advanced Warning message panel.
A D V		MMS-ADV-22	1200 x 300		ON SIDE ROAD <ul style="list-style-type: none"> • Shall not be used in conjunction with a regulatory speed sign.
A D V		MMS-ADV-23	1200 x 300		OVER 'X' m
A D V		MMS-ADV-24	1200 x 300		OVER 'X' GVM
A D V		MMS-ADV-25	1200 x 600		POWER LINE WORKS IN PROGRESS

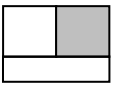

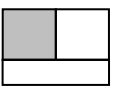



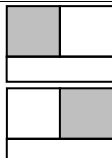

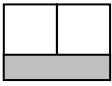

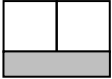

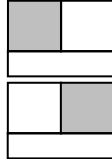
A D V		MMS-ADV-26	1200 x 300		PREPARE TO STOP
A D V		MMS-ADV-27	600 x 600		PREPARE TO STOP
A D V		MMS-ADV-28	1200 x 300		REDUCE SPEED
A D V		MMS-ADV-29	600 x 600		REDUCE SPEED
A D V		MMS-ADV-30	1200 x 600		REDUCE SPEED <ul style="list-style-type: none"> • Shall only be placed in advance of the primary regulatory speed sign.
A D V		MMS-ADV-31	600 x 600		ROAD CLOSED
A D V		MMS-ADV-32	1200 x 600		ROAD CLOSED
A D V		MMS-ADV-33	1200 x 600		ROAD CLOSED AHEAD
A D V		MMS-ADV-34	600 x 600		ROAD PLANT AHEAD
A D V		MMS-ADV-35	1200 x 600		ROAD PLANT AHEAD

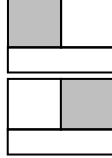
ADV		MMS-ADV-36	1200 x 600		ROAD PLANT ON SIDE ROAD
ADV		MMS-ADV-37	600 x 600		ROAD SIDE HAZARD <ul style="list-style-type: none"> • Shall only be used in conjunction with a speed restriction sign • Shall only be used as part of an after-care traffic control scheme
ADV		MMS-ADV-38	600 x 600		ROAD WORK AHEAD
ADV		MMS-ADV-39	1200 x 600		ROADWORKS AHEAD
ADV		MMS-ADV-40	1200 x 300		ROADWORKS
ADV		MMS-ADV-41	1200 x 600		ROADWORK ON SIDE ROAD
ADV		MMS-ADV-42	600 x 600		SIDE ROAD CLOSED
ADV		MMS-ADV-43	1200 x 600		SIDE ROAD CLOSED
ADV		MMS-ADV-44	600 x 600		TEMPORARY HAZARD MARKER
ADV		MMS-ADV-45	1200 x 300		TEMPORARY HAZARD MARKER

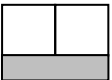

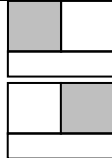



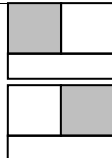



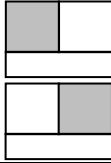

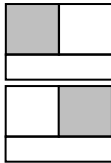

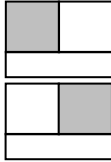

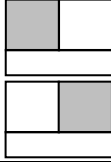
A D V		MMS-ADV-46	1200 x 300		<p>TEMPORARY HAZARD MARKER</p> <ul style="list-style-type: none"> Only to be used where the top two (2) panels contain a yellow background. Otherwise, the temporary hazard marker 'MMS-ADV-45' shall be used.
A D V		MMS-ADV-47	600 x 600		TRAFFIC CONTROLLER SYMBOLIC
A D V		MMS-ADV-48	600 x 600		TRAFFIC SIGNALS
A D V		MMS-ADV-49	600 x 600		TRAFFIC SIGNALS NOT IN USE
A D V		MMS-ADV-50	600 x 600		TRAFFIC SIGNALS NOT WORKING
A D V		MMS-ADV-51	600 x 600		TRUCK SYMBOLIC
A D V		MMS-ADV-52A	600 x 600		WORKER SYMBOLIC
A D V		MMS-ADV-52B	1200 x 600		WORKER SYMBOLIC
A D V		MMS-ADV-53	1200 x 300		<p>UHF CHANNEL XX</p> <ul style="list-style-type: none"> The use of channels 31-38 UHF is prohibited; channels 5 & 35 are for emergency use only.
A D V		MMS-ADV-54	600 x 600		<p>UHF CHANNEL XX</p> <ul style="list-style-type: none"> The use of channels 31-38 UHF is prohibited; channels 5 & 35 are for emergency use only.

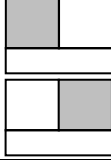

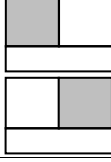

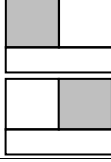

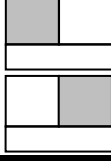

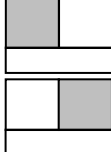

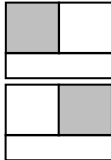

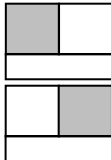

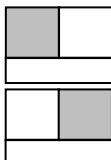

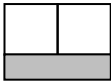

A D V		MMS-ADV-56	1200 x 300		DETOUR AHEAD
A D V		MMS-ADV-57	600 x 600		VERGE WORKS
A D V		MMS-ADV-58	1200 x 600		VERGE WORKS
A D V		MMS-ADV-59	1200 x 300		BRIDGE WORKS
A D V		MMS-ADV-60	1200 x 300		ON RAMP <ul style="list-style-type: none"> To be used to give advanced warning of works on the off-ramp.
A D V		MMS-ADV-79	600 x 600		BOOM BARRIER
A D V		MMS-ADV-80	600 x 600		RUMBLE STRIPS <ul style="list-style-type: none"> Shall only be used in conjunction with the sign MMS-ADV-81.
A D V		MMS-ADV-81	600 x 600		RUMBLE STRIPS <ul style="list-style-type: none"> Shall only be used in conjunction with the sign MMS-ADV-80.
A D V		MMS-ADV-82	1200 x 600		STOP HERE WHEN DIRECTED
A D V		MMS-ADV-83	600 x 600		MONITORING CAMERA

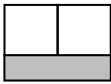

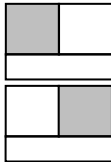

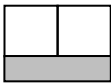

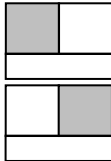

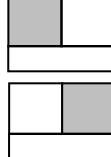

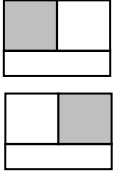
A D V		MMS-ADV-84	600 x 600		WORKS UNDER BRIDGE
A D V		MMS-ADV-85	1200 x 600		RAMP CLOSED AHEAD
A D V		MMS-ADV-86	1200 x 600		RAMP CLOSED
A D V		MMS-ADV-87	600 x 600		RAMP CLOSED
A D V		MMS-ADV-88	600 x 600		CYCLISTS IN LANE
A D V		MMS-ADV-89	1200 x 600		CYCLISTS IN LANE
A D V		MMS-ADV-90	600 x 600		QUEUED TRAFFIC AHEAD <ul style="list-style-type: none"> • Shall only be used in conjunction with the sign MMS-ADV-91.
A D V		MMS-ADV-91	600 x 600		QUEUED TRAFFIC (SYMBOLIC) <ul style="list-style-type: none"> • Shall only be used in conjunction with the sign MMS-ADV-90.
A D V		MMS-ADV-92	600 x 600		CYCLISTS (SYMBOLIC)
A D V		MMS-ADV-93	600 x 600		BICYCLE LANE CLOSED AHEAD
A D V		MMS-ADV-94	1200 x 300		SLOW BUS AHEAD <ul style="list-style-type: none"> • To be used to give advance warning of autonomous bus trials

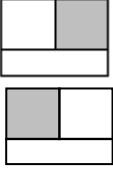
A D V		MMS-ADV-95	1200 x 300		DRIVERLESS BUS <ul style="list-style-type: none"> To be used to provide warning of autonomous bus trials
A D V		MMS-ADV-96	600 x 600		AUTONOMOUS BUS
A D V		MMS-ADV-97	600 x 600		MOWING AHEAD
A D V		MMS-ADV-98	1200 x 300		MOWING
A D V		MMS-ADV-99	600 x 600		RIDE ON MOWER SYMBOLIC
A D V		MMS-ADV-100	1200 x 600		PILOT VEHICLE / FOLLOW ME <ul style="list-style-type: none"> To be mounted to the roadworks pilot vehicle
A D V		MMS-ADV-101	600 x 600		ON SIDE ROAD <ul style="list-style-type: none"> Shall not be used in conjunction with a regulatory speed sign.

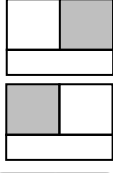

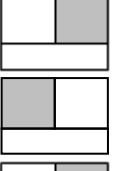

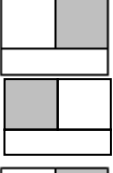









Group	<u>POSITION SERIES SIGNS</u>			SIGN APPLICATION AND DESCRIPTION	
	Sign	Main Roads Sign Number	Panel Size (mm)	<ol style="list-style-type: none"> 1. Sign panels shall only be located in the frame location as shown. 2. Left side multi-message sign shown only. 3. Multi-message signs located on both sides of the roadway shall form a mirrored image of the signs being displayed. 4. For sign specification go to www.mainroads.wa.gov.au > Technical & Commercial > Technical Library > Signs Index > Multi Message Signs Standards 5. For multi-message signs frame refer to Main Roads standard drawing 201031-0155. 	



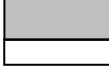

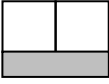

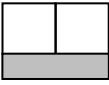
P O S		MMS-POS-1(L)	600 x 600		LANE STATUS
P O S		MMS-POS-1(R)	600 x 600		LANE STATUS
P O S		MMS-POS-2(R)	600 x 600		LANE STATUS
P O S		MMS-POS-2(L)	600 x 600		LANE STATUS
P O S		MMS-POS-3(R)	600 x 600		LANE STATUS
P O S		MMS-POS-3(L)	600 x 600		LANE STATUS
P O S		MMS-POS-4	600 x 600		LANE STATUS
P O S		MMS-POS-5	600 x 600		LANE STATUS
P O S		MMS-POS-6(L)	600 x 600		LANE STATUS

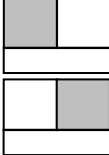
P O S		MMS-POS-6(R)	600 x 600		LANE STATUS
P O S		MMS-POS-7(L)	600 x 600		LANE STATUS
P O S		MMS-POS-7(R)	600 x 600		LANE STATUS
P O S		MMS-POS-8	1200 x 300		LANE STATUS <ul style="list-style-type: none"> • Should be used with the ON SIDE ROAD panel to indicate the direction of the side road where road work is being carried out
P O S		MMS-POS-9(L)	600 x 600		MERGE LEFT
P O S		MMS-POS-10(L)	1200 x 300		MERGE LEFT
P O S		MMS-POS-9(R)	600 x 600		MERGE RIGHT
P O S		MMS-POS-10(R)	1200 x 300		MERGE RIGHT
P O S		MMS-POS-11	600 x 600		LANE STATUS
P O S		MMS-POS-12	600 x 600		LANE STATUS

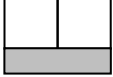





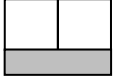

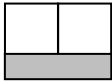

P O S		MMS-POS-13 (L)	600 x 600		LANE STATUS
P O S		MMS-POS-13(R)	600 x 600		LANE STATUS
P O S		MMS-POS-14(L)	600 x 600		LANE STATUS
P O S		MMS-POS-14(R)	600 x 600		LANE STATUS
P O S		MMS-POS-15(L)	600 x 600		LANE STATUS
P O S		MMS-POS-15(R)	600 x 600		LANE STATUS

Group	<u>TRAFFIC DIVERSION SERIES SIGNS</u>			SIGN APPLICATION AND DESCRIPTION	
	Sign	Main Roads Sign Number	Panel Size (mm)	<ol style="list-style-type: none"> 1. Sign panels shall only be located in the frame location as shown. 2. Left side multi-message sign shown only. 3. Multi-message signs located on both sides of the roadway shall form a mirrored image of the signs being displayed. 4. For sign specification go to www.mainroads.wa.gov.au > Technical & Commercial > Technical Library > Signs Index > Multi Message Signs Standards 5. For multi-message signs frame refer to Main Roads standard drawing 201031-0155. 	

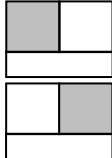

D I V		MMS-DIV-1	600 x 600		DETOUR
D I V		MMS-DIV-2(L)	1200 x 600		DETOUR FOR HEAVY VEHICLES LEFT
D I V		MMS-DIV-2(R)	1200 x 600		DETOUR FOR HEAVY VEHICLES RIGHT
D I V		MMS-DIV-3(L)	1200 x 600		DETOUR FOR HIGH VEHICLES LEFT
D I V		MMS-DIV-3(R)	1200 x 600		DETOUR FOR HIGH VEHICLES RIGHT
D I V		MMS-DIV-4(L)	1200 x 300		DETOUR LEFT ARROW
D I V		MMS-DIV-4(R)	1200 x 300		DETOUR RIGHT ARROW
D I V		MMS-DIV-5	600 x 600		DETOUR MARKER

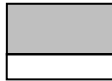

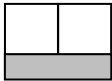

D I V		MMS-DIV-6	1200 x 300		LOCAL TRAFFIC ONLY <ul style="list-style-type: none"> • Shall not be used in conjunction with a regulatory sign.
D I V		MMS-DIV-7	600 x 600		LOCAL TRAFFIC ONLY <ul style="list-style-type: none"> • Shall not be used in conjunction with a regulatory sign.
D I V		MMS-DIV-8	1200 x 300		DETOUR LEFT
D I V		MMS-DIV-9	1200 x 300		DETOUR AHEAD

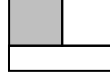
Group	<u>TERMINATION SERIES SIGNS</u>			SIGN APPLICATION AND DESCRIPTION	
	Sign	Main Roads Sign Number	Panel Size (mm)		
				<ol style="list-style-type: none"> 1. Sign panels shall only be located in the frame location as shown. 2. Left side multi-message sign shown only. 3. Multi-message signs located on both sides of the roadway shall form a mirrored image of the signs being displayed. 4. For sign specification go to www.mainroads.wa.gov.au > Technical & Commercial > Technical Library > Signs Index > Multi Message Signs Standards 5. For multi-message signs frame refer to Main Roads standard drawing 201031-0155. 	



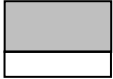

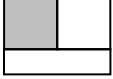

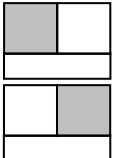
TER		MMS-TER-1	1200 x 300		DRIVE SAFELY
TER		MMS-TER-2	1200 x 600		END BLASTING AREA
TER		MMS-TER-3	600 x 600		END DETOUR
TER		MMS-TER-4	600 x 600		END ROADWORK
TER		MMS-TER-5	1200 x 600		END ROADWORK
TER		MMS-TER-6	1200 x 300		THANK YOU



Group	ROAD CONDITION SERIES SIGNS			SIGN APPLICATION AND DESCRIPTION	
	Sign	Main Roads Sign Number	Panel Size (mm)		
				<ol style="list-style-type: none"> 1. Sign panels shall only be located in the frame location as shown. 2. Left side multi-message sign shown only. 3. Multi-message signs located on both sides of the roadway shall form a mirrored image of the signs being displayed. 4. For sign specification go to www.mainroads.wa.gov.au > Technical & Commercial > Technical Library > Signs Index > Multi Message Signs Standards. 5. For multi-message signs frame refer to Main Roads standard drawing 201031-0155. 	

R C		MMS-RC-1	600 x 600		LOOSE STONES
R C		MMS-RC-2	600 x 600		LOOSE SURFACE
R C		MMS-RC-3	1200 x 600		NEW WORK NO LINES MARKED
R C		MMS-RC-4	600 x 600		NO LINES
R C		MMS-RC-5	600 x 600		ROUGH SURFACE
R C		MMS-RC-6	600 x 600		SLIPPERY
R C		MMS-RC-8	600 x 600		SOFT EDGES
R C		MMS-RC-9	600 x 600		TRAFFIC HAZARD <ul style="list-style-type: none"> • For emergency use only, see Clause 4.20.1 of AS 1742.3.
R C		MMS-RC-10	600 x 600		WATER OVER ROAD

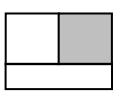

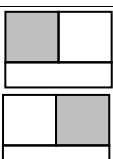

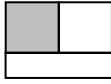

R C		MMS-RC-11	1200 x 600		WATER OVER ROAD
R C		MMS-RC-12	600 x 600		WET BITUMEN
R C		MMS-RC-13	600 x 600		ROUGH SURFACE (CYCLIST)



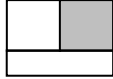



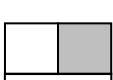

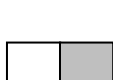

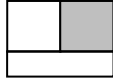

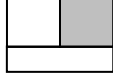



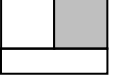

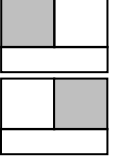
Group	PEDESTRIAN SERIES SIGNS			SIGN APPLICATION AND DESCRIPTION	
	Sign	Main Roads Sign Number	Panel Size (mm)		
				1. Sign panels shall only be located in the frame location as shown. 2. Left side multi-message sign shown only. 3. Multi-message signs located on both sides of the roadway shall form a mirrored image of the signs being displayed. 4. For sign specification go to www.mainroads.wa.gov.au > Technical & Commercial > Technical Library > Signs Index > Multi Message Signs Standards 5. For multi-message signs frame refer to Main Roads standard drawing 201031-0155.	

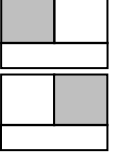



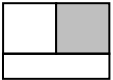



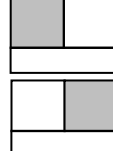

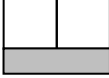
P E D		MMS-PED-1	600 x 600		FOOTPATH CLOSED
P E D		MMS-PED-2	600 x 600		FOOTPATH TRIP HAZARD
P E D		MMS-PED-3(L)	1200 x 300		PEDESTRIANS LEFT ARROW
P E D		MMS-PED-3(R)	1200 x 300		PEDESTRIANS RIGHT ARROW
P E D		MMS-PED-4	600 x 600		PEDESTRIANS WATCH YOUR STEP
P E D		MMS-PED-5	600 x 600		SLIPPERY (FOOTPATH)
P E D		MMS-PED-6	600 x 600		USE OTHER FOOTPATH
P E D		MMS-PED-7	600 x 600		CYCLISTS DISMOUNT <ul style="list-style-type: none"> • See section 6.1.5 for conditions of use
P E D		MMS-PED-8	600 x 600		PATH CLOSED

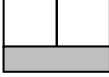
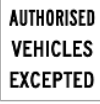
Group	<u>EVENT SERIES SIGNS</u>			SIGN APPLICATION AND DESCRIPTION	
	Sign	Main Roads Sign Number	Panel Size (mm)		
EVE		MMS-EVE-1	600 x 600		CYCLIST
EVE		MMS-EVE-2	600 x 600		END EVENT
EVE		MMS-EVE-3	600 x 600		EVENT AHEAD
EVE		MMS-EVE-4	1200 x 300		EVENT IN PROGRESS
EVE		MMS-EVE-5	1200 x 600		EVENT ON SIDE ROAD
EVE		MMS-EVE-6	600 x 600		PEDESTRIANS
EVE		MMS-EVE-7	600 x 600		RUNNER
EVE		MMS-EVE-9	1200 x 600		END EVENT
EVE		MMS-EVE-10	1200 x 600		EVENT AHEAD

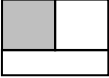

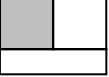



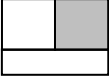









Group	REGULATORY SERIES SIGNS			SIGN APPLICATION AND DESCRIPTION	
	Sign	Main Roads Sign Number	Panel Size (mm)		
				1. Sign panels shall only be located in the frame location as shown. 2. Left side multi-message sign shown only. 3. Multi-message signs located on both sides of the roadway shall form a mirrored image of the signs being displayed. 4. For sign specification go to www.mainroads.wa.gov.au >Technical & Commercial > Technical Library > Signs Index > Multi Message Signs Standards 5. For multi-message signs frame refer to Main Roads standard drawing 201031-0155.	











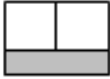

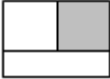

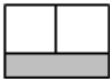

REG		MMS-REG-1(40)	600 x 600		40 km/h SPEED SIGN
REG		MMS-REG-1(50)	600 x 600		50 km/h SPEED SIGN <ul style="list-style-type: none"> Shall only be used to terminate a temporary speed zone.
REG		MMS-REG-1(60)	600 x 600		60 km/h SPEED SIGN
REG		MMS-REG-1(70)	600 x 600		70 km/h SPEED SIGN <ul style="list-style-type: none"> Shall only be used to terminate a temporary speed zone.
REG		MMS-REG-1(80)	600 x 600		80 km/h SPEED SIGN
REG		MMS-REG-1(90)	600 x 600		90 km/h SPEED SIGN <ul style="list-style-type: none"> Shall only be used to terminate a temporary speed zone.
REG		MMS-REG-1(100)	600 x 600		100 km/h SPEED SIGN <ul style="list-style-type: none"> Shall only be used to terminate a temporary speed zone.
REG		MMS-REG-1(110)	600 x 600		110 km/h SPEED SIGN <ul style="list-style-type: none"> Shall only be used to terminate a temporary speed zone.

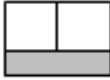
REG		MMS-REG-2(40)	600 x 600	 <p>END 40 km/h SYMBOLIC</p> <ul style="list-style-type: none"> Shall only be used to terminate a temporary speed zone on a road that had not been speed zoned, or on a mobile convoy
REG		MMS-REG-2(60)	600 x 600	 <p>END 60 km/h SYMBOLIC</p> <ul style="list-style-type: none"> Shall only be used to terminate a temporary speed zone on a road that had not been speed zoned or on a mobile convoy.
REG		MMS-REG-2(80)	600 x 600	 <p>END 80 km/h SYMBOLIC</p> <ul style="list-style-type: none"> Shall only be used to terminate a temporary speed zone on a road that had not been speed zoned or on a mobile convoy.
REG		MMS-REG-3	600 x 600	 <p>NO ENTRY SYMBOLIC</p>
REG		MMS-REG-4(L)	600 x 600	 <p>NO LEFT TURN SYMBOLIC</p>
REG		MMS-REG-4(R)	600 x 600	 <p>NO RIGHT TURN SYMBOLIC</p>
REG		MMS-REG-5	600 x 600	 <p>NO OVERTAKING OR PASSING</p>
REG		MMS-REG-6(L)	600 x 600	 <p>LEFT ONLY</p>
REG		MMS-REG-6(R)	600 x 600	 <p>RIGHT ONLY</p>
REG		MMS-REG-7	600 x 600	 <p>SHARED PATH</p>

R E G		MMS-REG-8	1200 x 300		BUSES EXCEPTED
R E G		MMS-REG-9	1200 x 300		BICYCLES EXCEPTED
R E G		MMS-REG-10	600 x 600		AUTHORISED VEHICLES EXCEPTED
R E G		MMS-REG-11	600 x 600		BUSES AND TAXIS EXCEPTED
R E G		MMS-REG-12	600 x 600		BUSES AND BICYCLES EXCEPTED
R E G		MMS-REG-13	600 x 600		AT STREET NAME
R E G		MMS-REG-14	600 x 600		BICYCLE LANE CLOSED (SYMBOLIC)

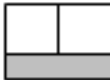
Group	INCIDENT, FIRE AND EMERGENCY SERIES SIGNS			SIGN APPLICATION AND DESCRIPTION	
	Sign	Main Roads Sign Number	Panel Size (mm)	6. Sign panels shall only be located in the frame location as shown. 7. Left side multi-message sign shown only. 8. Multi-message signs located on both sides of the roadway shall form a mirrored image of the signs being displayed. 9. For sign specification go to www.mainroads.wa.gov.au >Technical & Commercial > Technical Library > Signs Index > Multi Message Signs Standards 10. For multi-message signs frame refer to Main Roads standard drawing 201031-0155.	

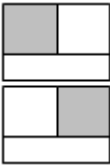
		MMS-ADV-61	600 x 600		BUSHFIRE SYMBOLIC
		MMS-ADV-62	600 x 600		WATER OVER ROAD SYMBOLIC
		MMS-ADV-63	600 x 600		CRASH SYMBOLIC
		MMS-ADV-64	600 x 600		HAZARDOUS MATERIAL SYMBOLIC
		MMS-ADV-65	600 x 600		BUSH FIRE
		MMS-ADV-66	600 x 600		ROAD FLOODED
		MMS-ADV-67	600 x 600		ROAD CRASH
		MMS-ADV-68	600 x 600		HAZARDOUS MATERIAL

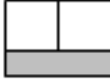
		MMS-ADV-69	1200 x 300		EMERGENCY AHEAD
		MMS-ADV-70	600 x 600		POLICE CONTROL
		MMS-ADV-71	1200 x 300		POLICE CONTROL AHEAD
		MMS-ADV-73	600 x 600		BURNING OFF
		MMS-ADV-74	1200 x 300		BURNING OFF
		MMS-ADV-75	600 x 600		HEADLIGHTS ON
		MMS-ADV-76	1200 x 300		BUSH FIRE
		MMS-ADV-77	600 x 600		SMOKE HAZARD
		MMS-ADV-78	1200 x 300		SMOKE HAZARD

Group	<u>MISCELLANEOUS SIGNS</u>			<p>SIGN APPLICATION AND DESCRIPTION</p> <ol style="list-style-type: none"> 1. Sign panels shall only be located in the frame location as shown. 2. Left side multi-message sign shown only. 3. Multi-message signs located on both sides of the roadway shall form a mirrored image of the signs being displayed. 4. For sign specification go to www.mainroads.wa.gov.au > Technical & Commercial > Technical Library > Signs Index > Multi Message Signs Standards 5. For multi-message signs frame refer to Main Roads standard drawing 201031-0155.
	Sign	Main Roads Sign Number	Panel Size (mm)	

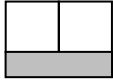
		N/A	1200 x 300	<p>BLANK - BLACK</p>  <ul style="list-style-type: none"> • May be used in lieu of 'THANK YOU', 'DRIVE SLOWLY' and/or 'DRIVE SAFELY' to reduce redundant messages.
--	---	-----	------------	--

Multi-Message Sign Combination Examples (not all combinations shown)
 For sign specification go to www.mainroads.wa.gov.au > Technical & Commercial > Technical Library > Signs Index > Multi Message Signs Standards

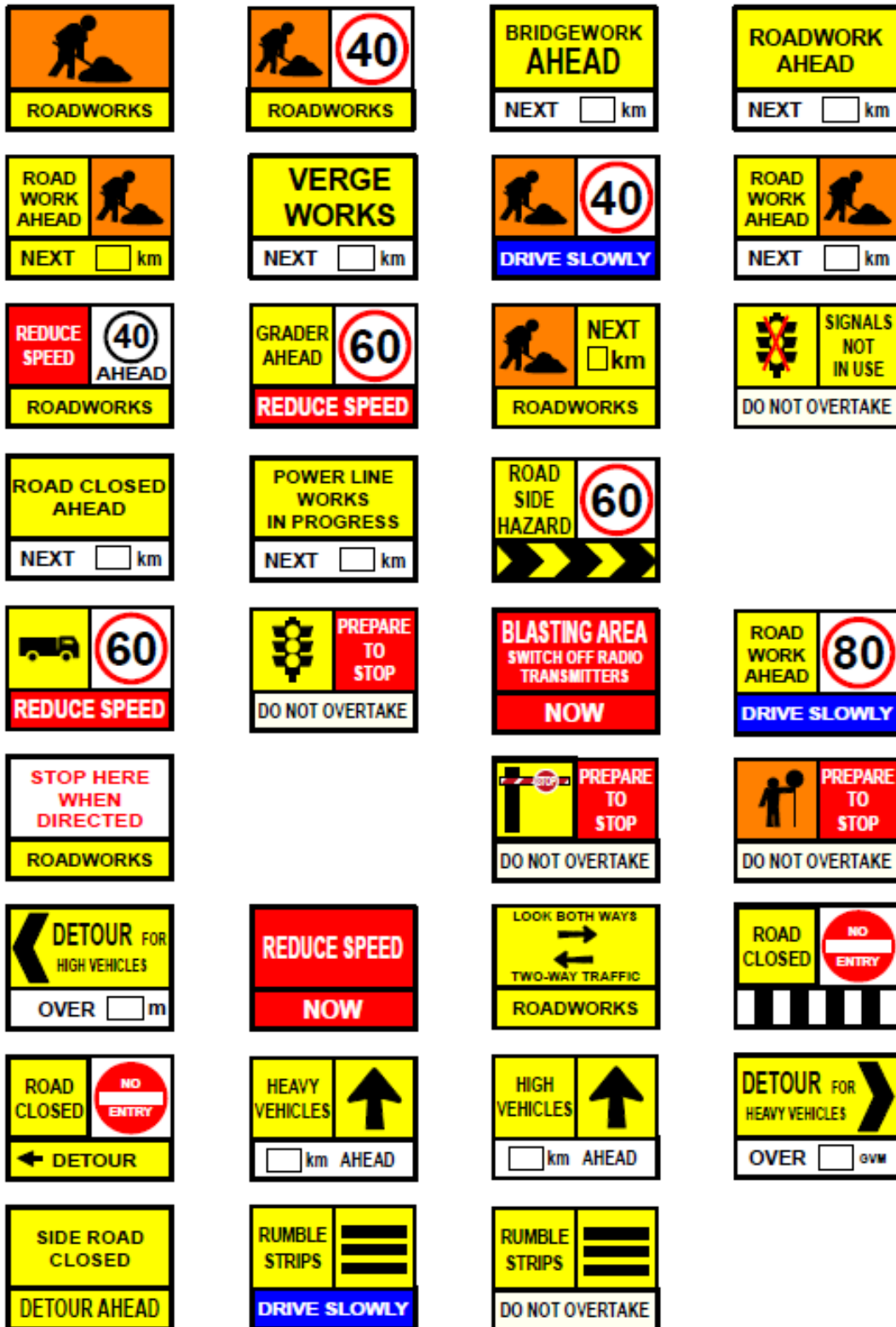

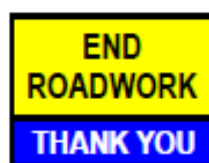
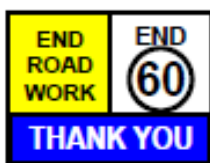
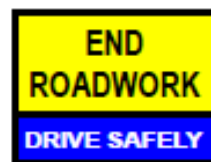
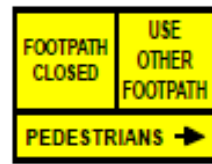
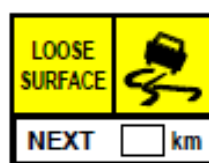
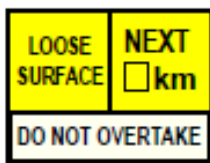
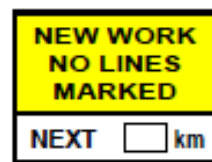
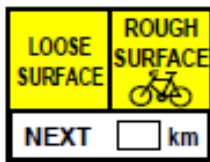
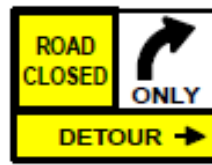

END OF DOCUMENT

